

Stella Maidment and Lorena Roberts

Happy House

New Edition

Activity Book

1

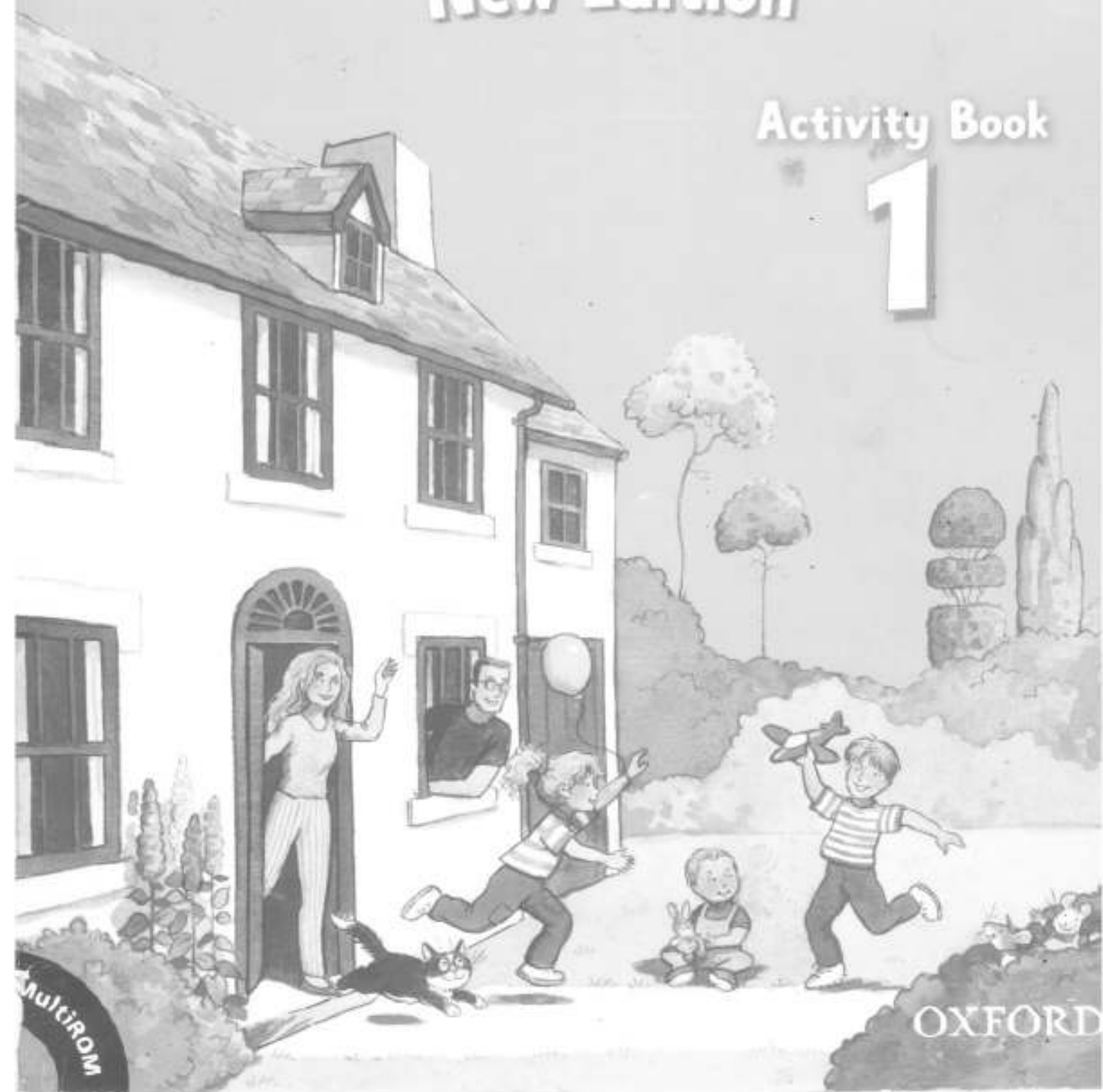

MultiROM

OXFORD

Stella Maidment and Lorena Roberts

Happy House

New Edition

Activity Book

1



OXFORD
UNIVERSITY PRESS

1 Welcome to Happy House!

1 Listen and circle.

1			
2			
3			
4			
5			
6			

Look and circle. Hello or Goodbye?

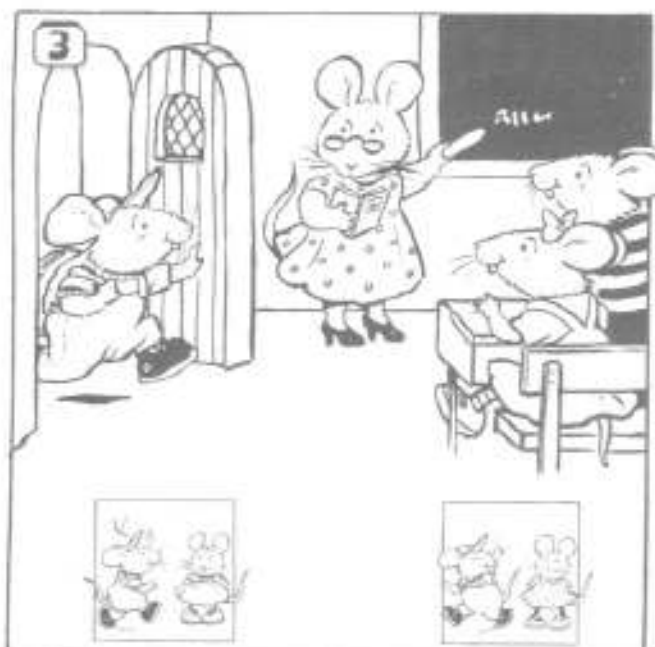

Draw and say.



Match and colour.

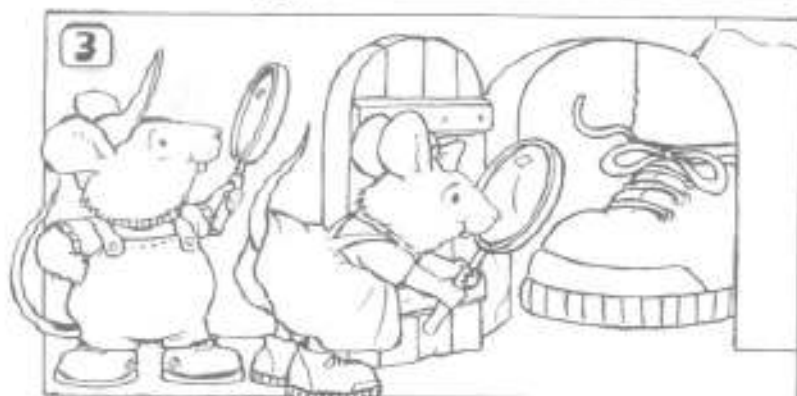
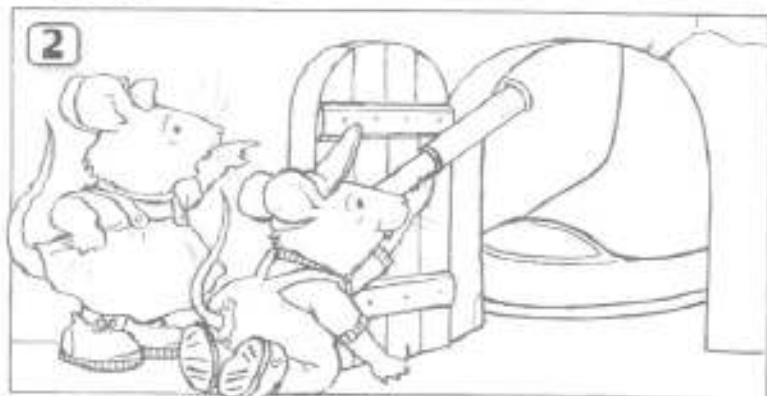
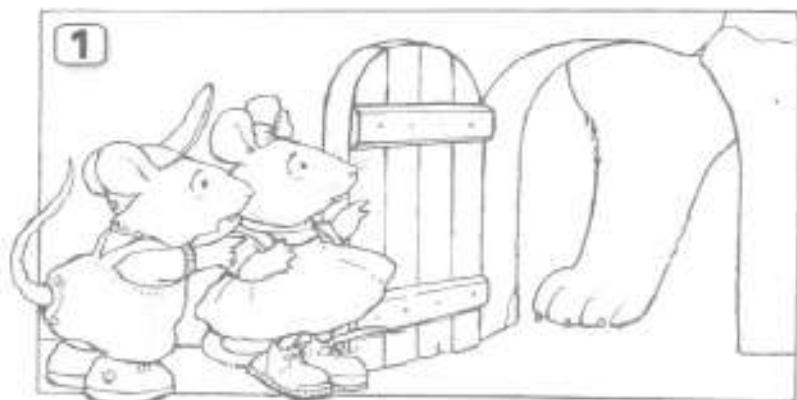

Draw.



Put the pictures in order. Write 1, 2, 3.

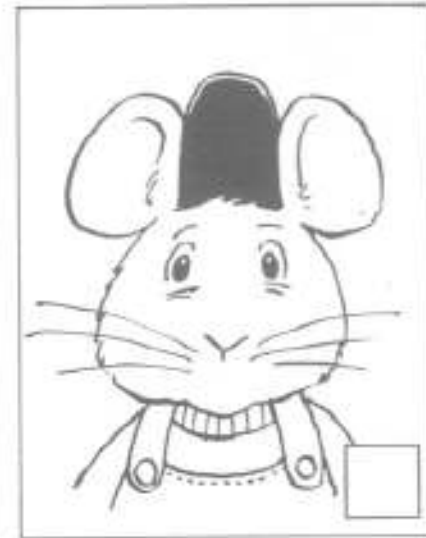
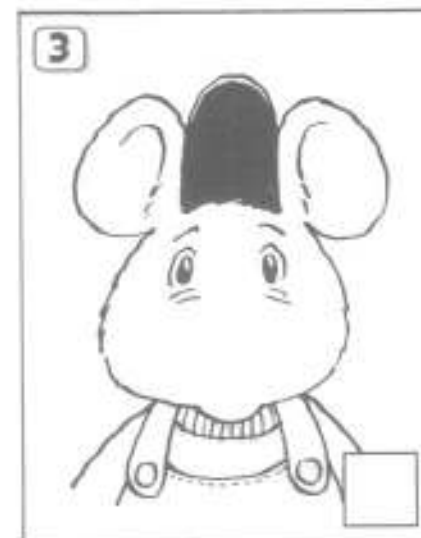
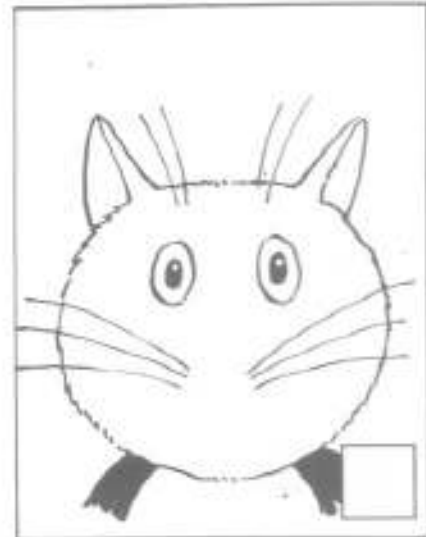
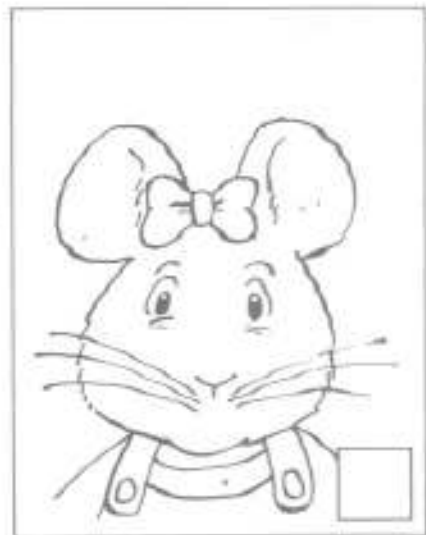
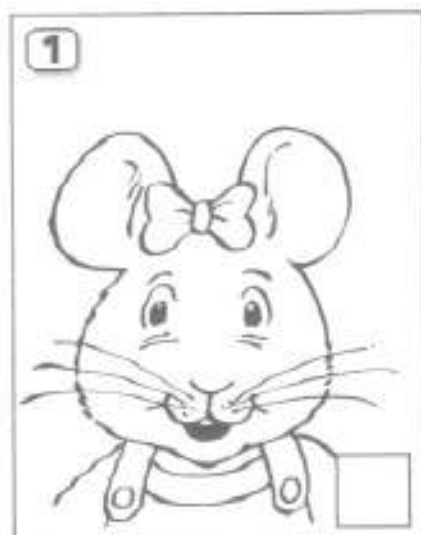

Match and say.

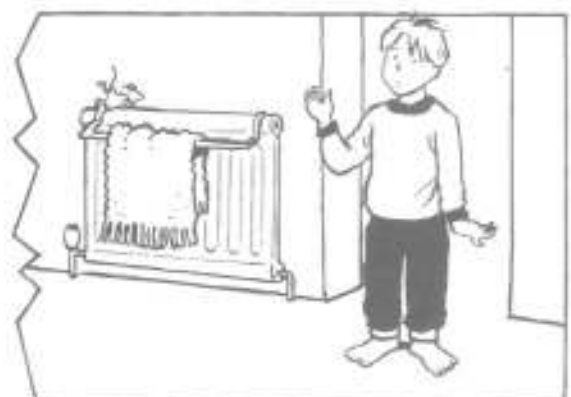
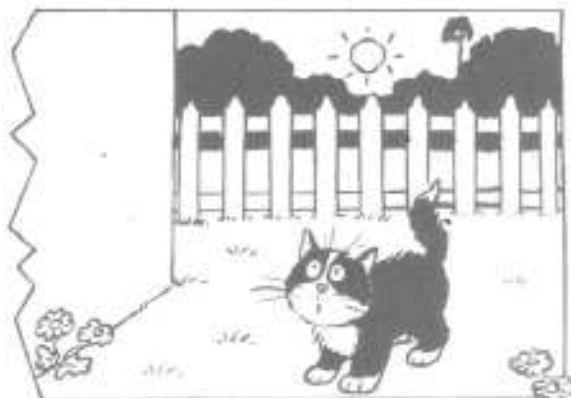
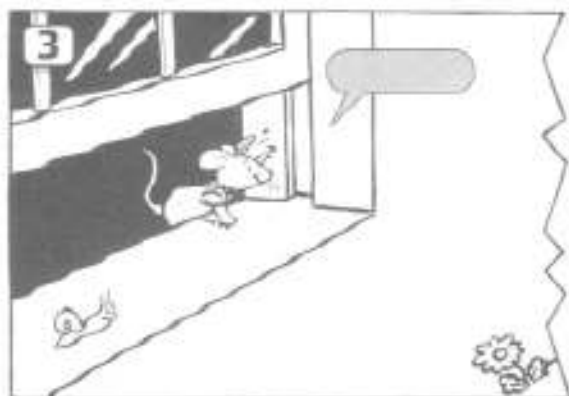

Find and draw.



Look and say.

1



2



3



4



5



Look and say.

1



2



3



Look and say.

1



2



Match and stick.

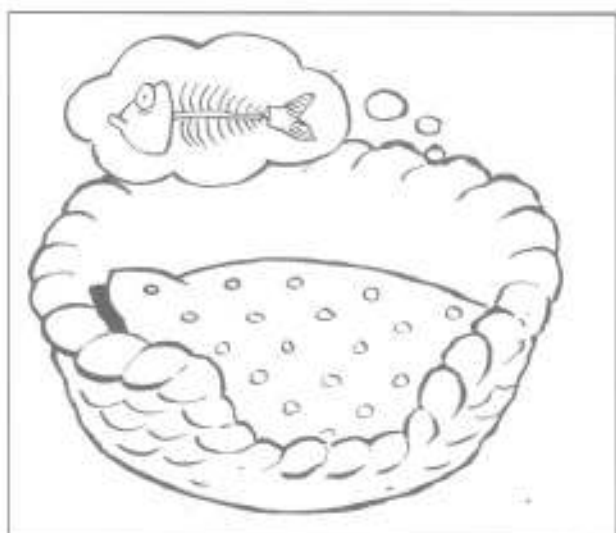

2 Pens and pencils

1 Listen and circle.

1

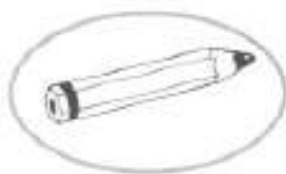

2



3



4



5



6



Colour and say.

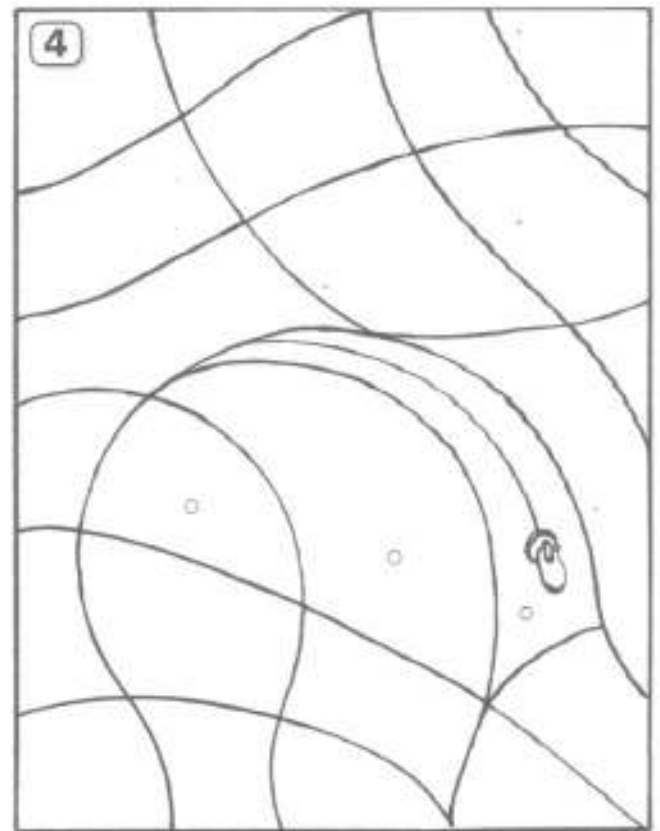
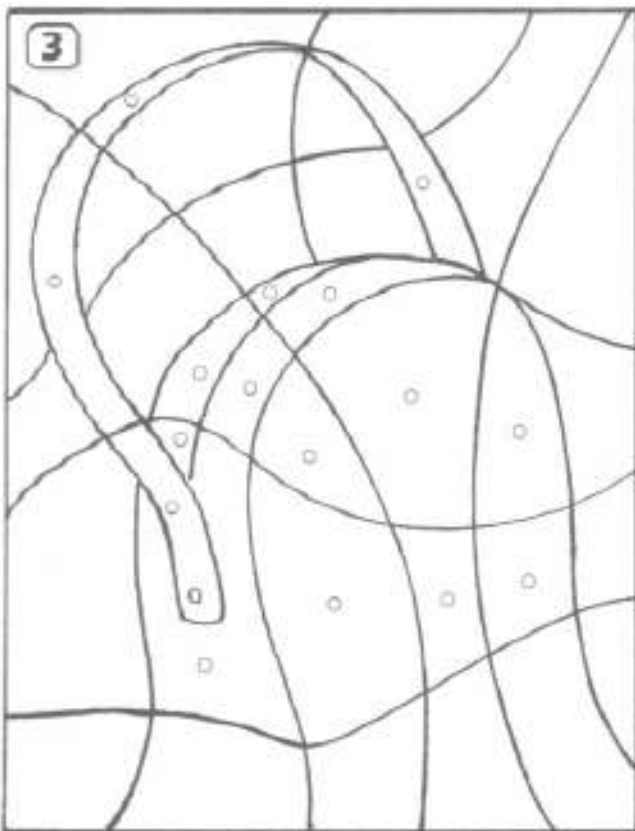
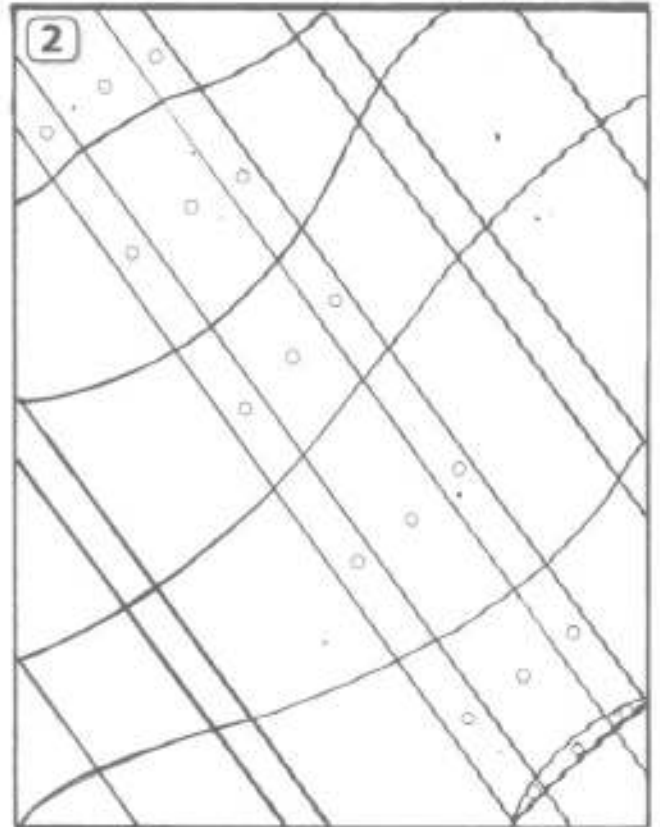
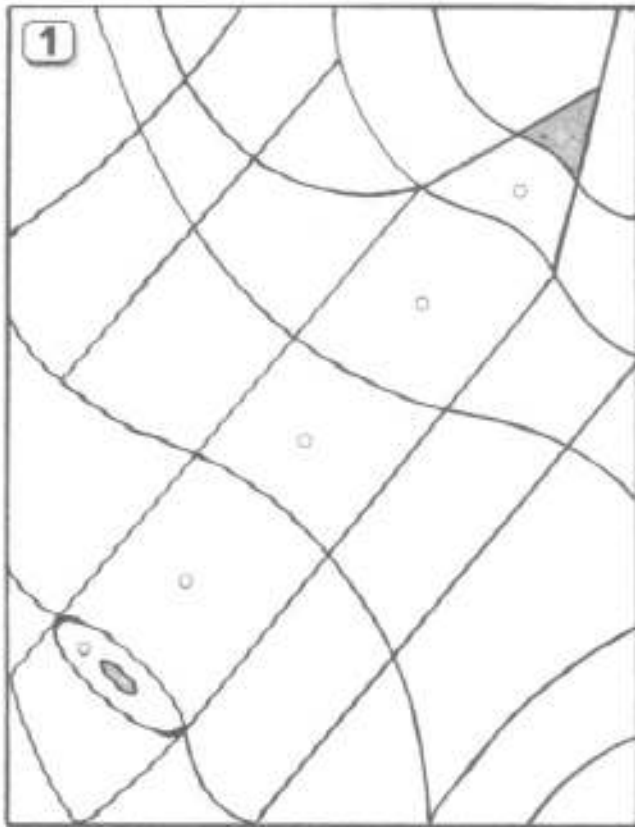

Draw and say.

About
me!



Write the numbers.

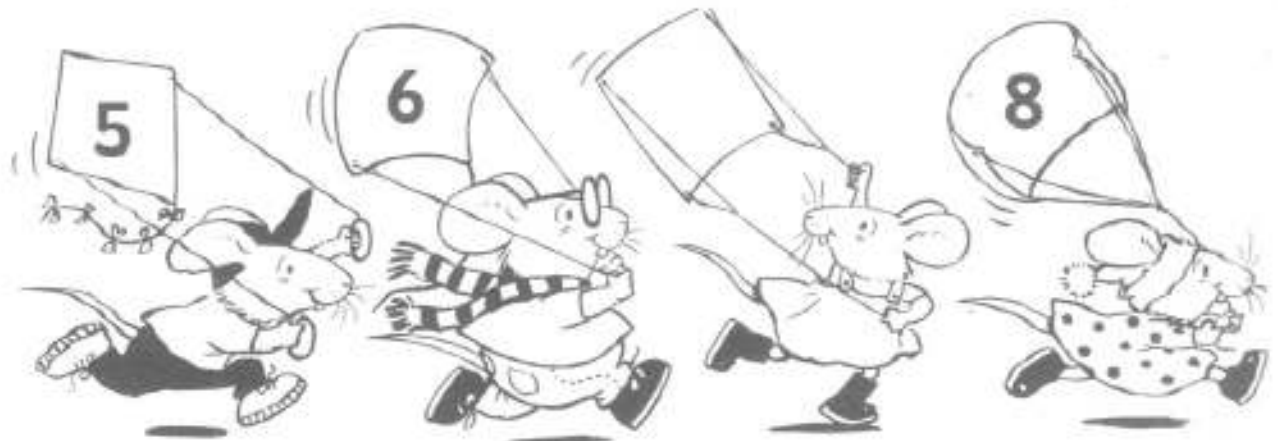
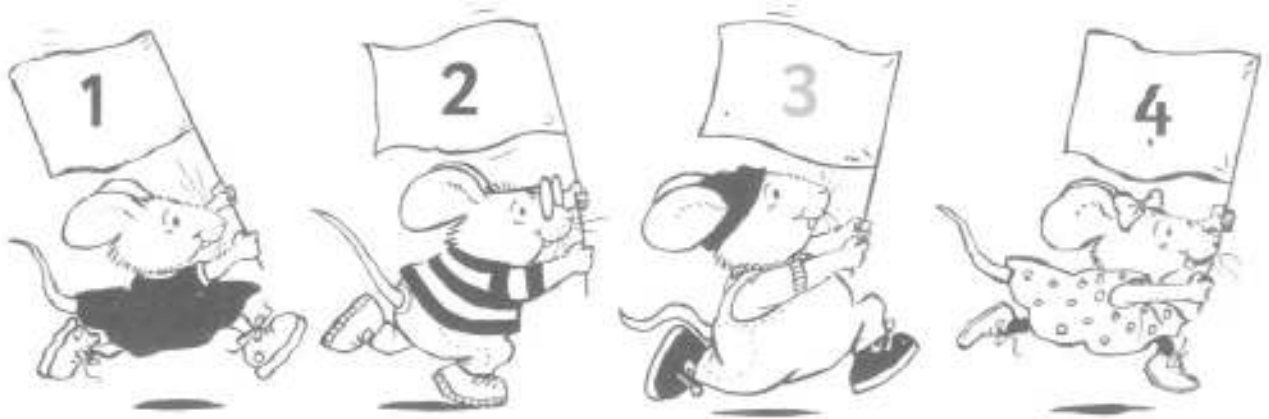

Draw one more and write the numbers.

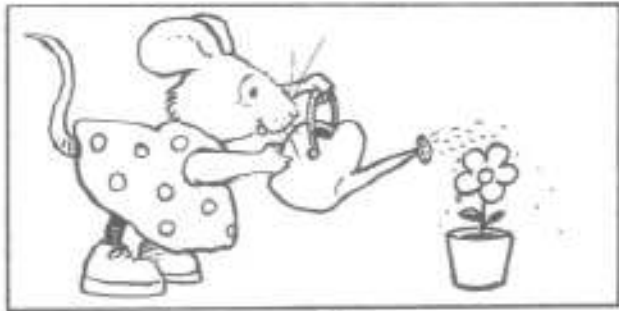

1



2

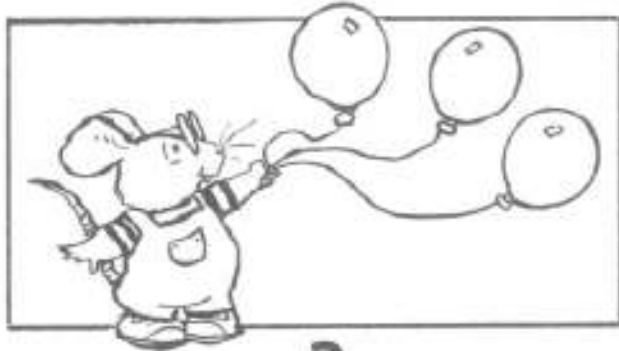

3

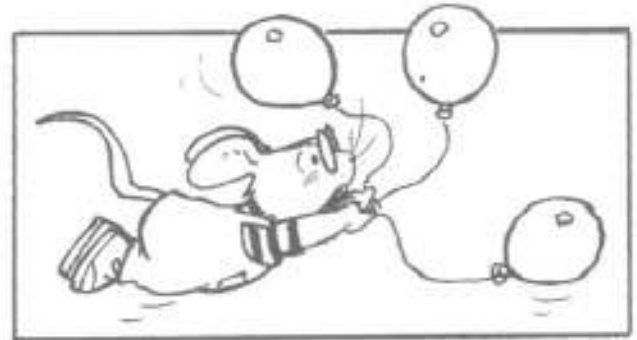

5

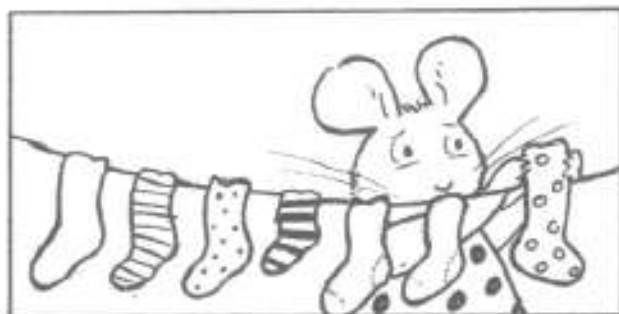

7

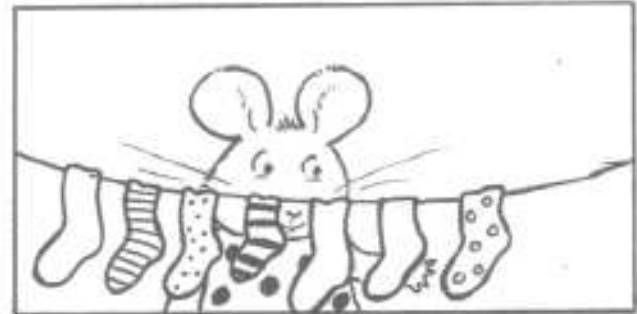

Match.



4

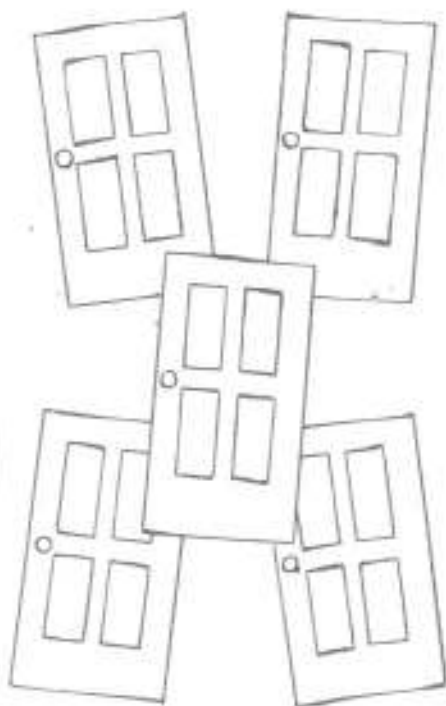

2

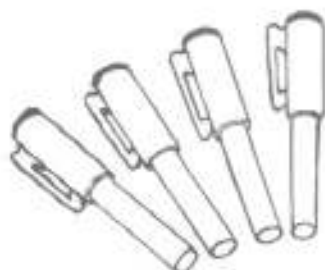

9

8

3

10



1

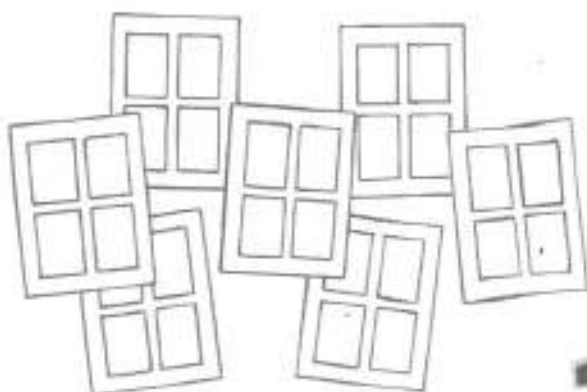

5



6

7



Find and draw.



Look and say.

①



②



③



④



⑤



⑥



Look and say.

1

2

3

4

5



Look and say.

6

7

8

9

10



Match and stick.

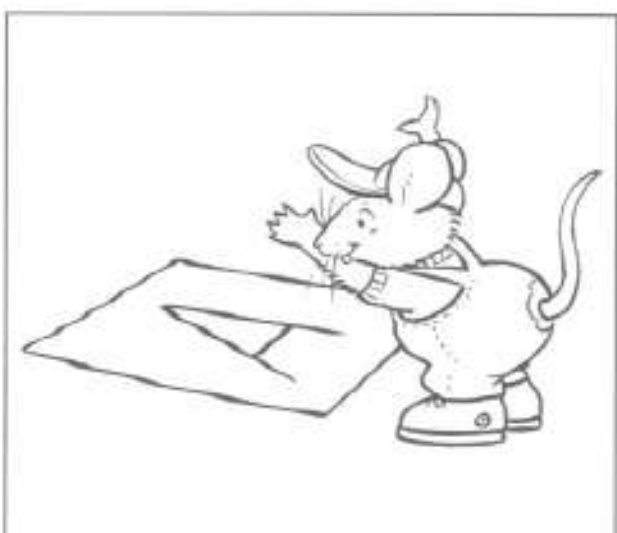
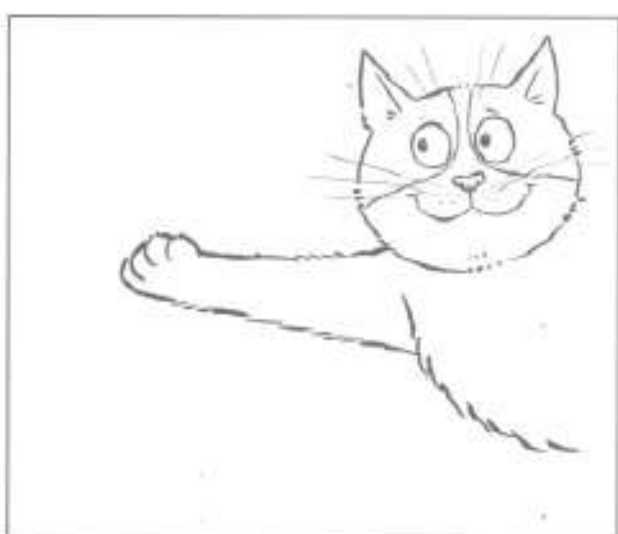
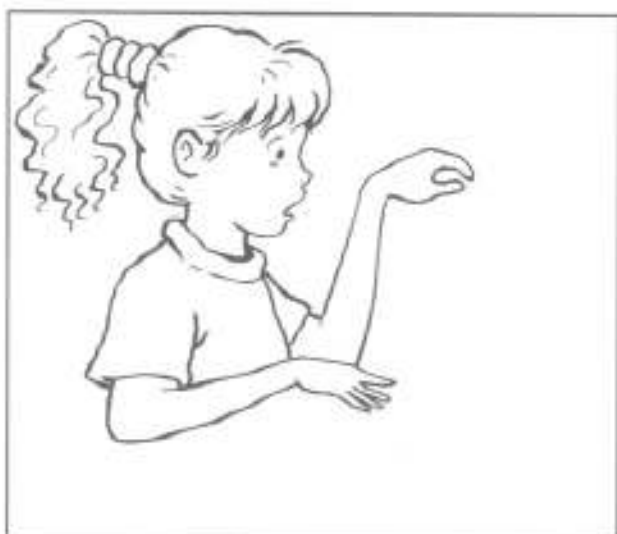
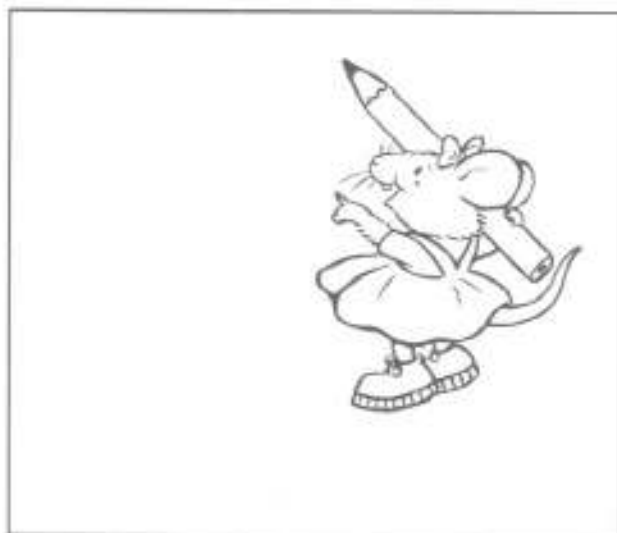

3

Come and play!

Complete the toys and say.

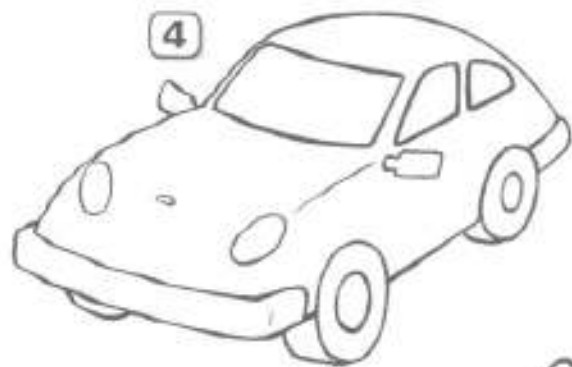
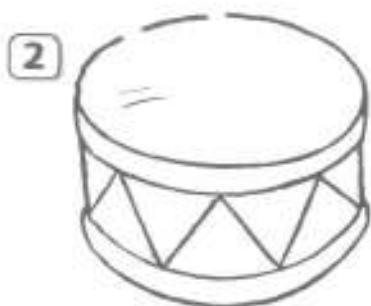
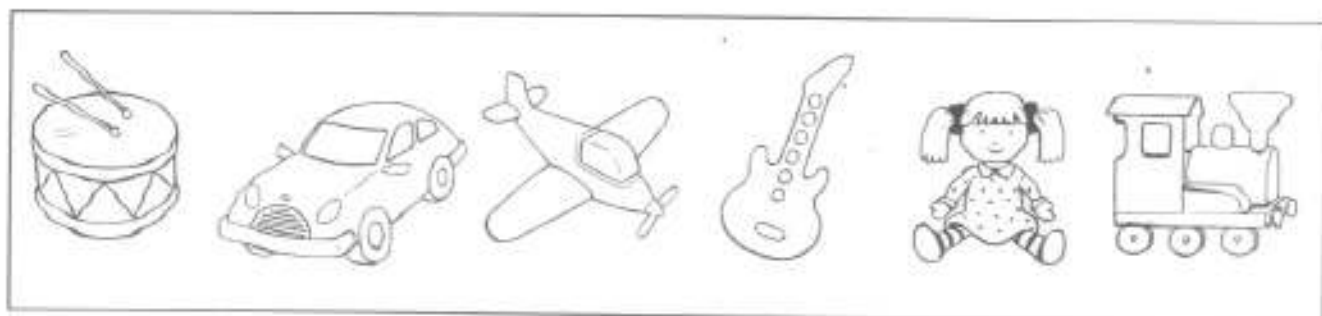

Match. Then write the numbers and say.

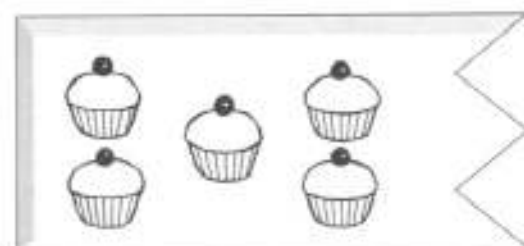
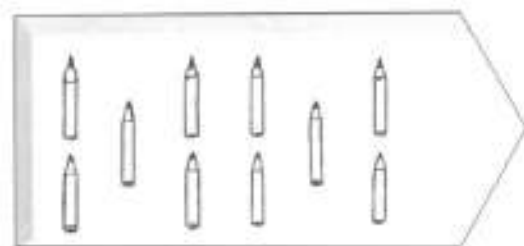
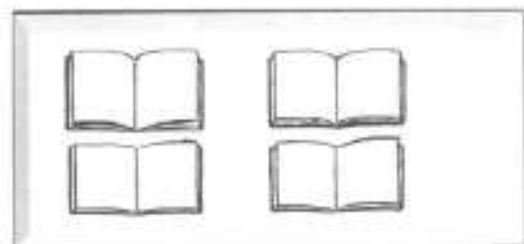
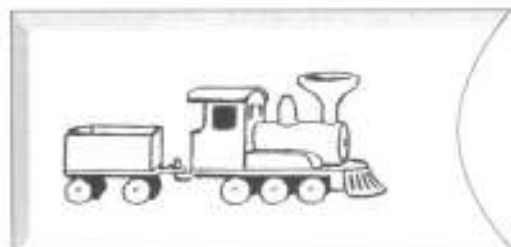
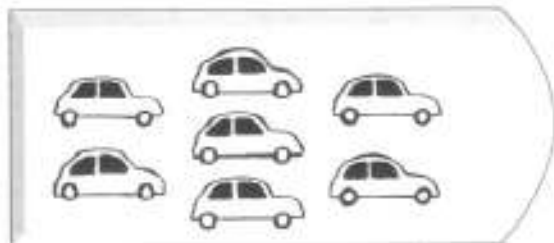

Draw and say.

About
me!

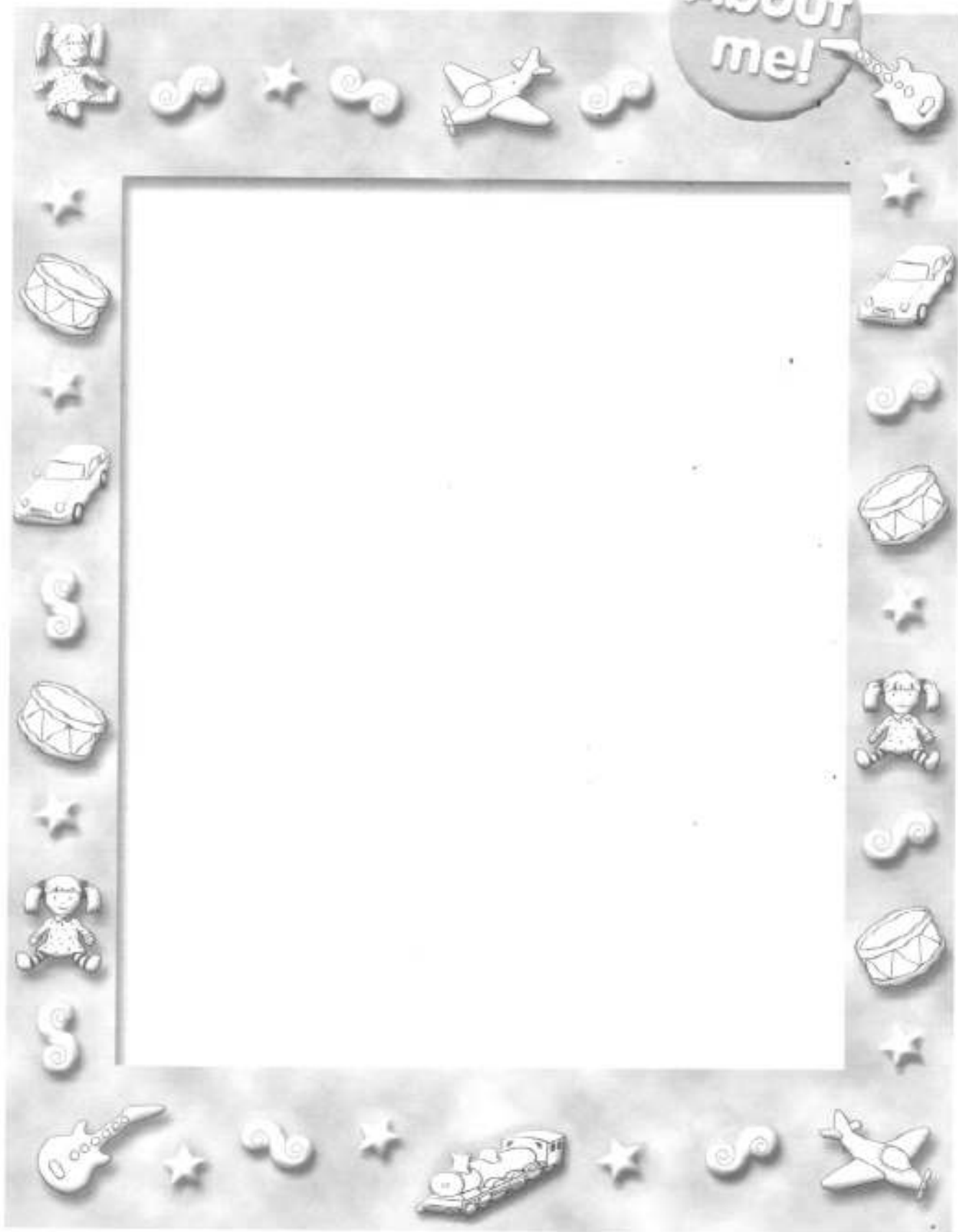

1 Listen and colour.

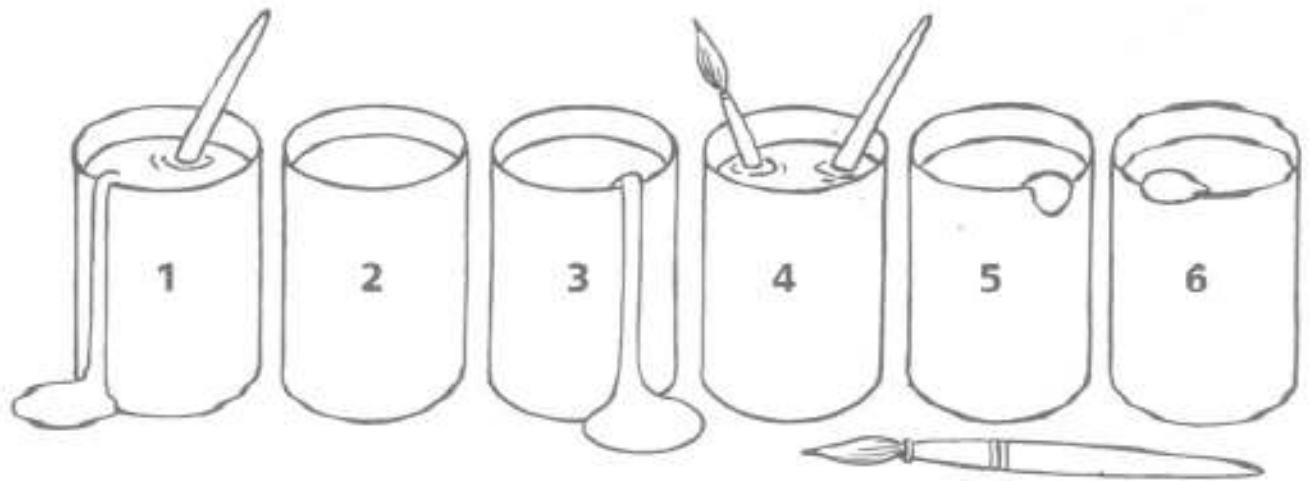

Now use the key to colour the picture.

MUESTRA SIN VALOR COMERCIAL
FOTOCOPIAR LIBROS
ES DELITO
(LEY 11723)





Match and say.

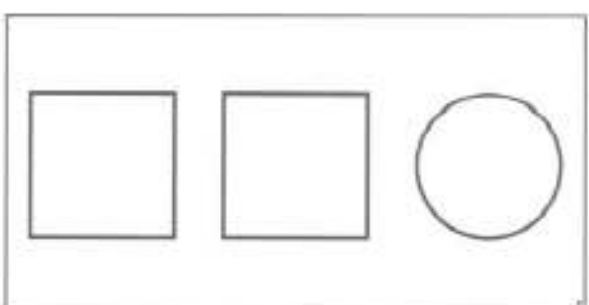
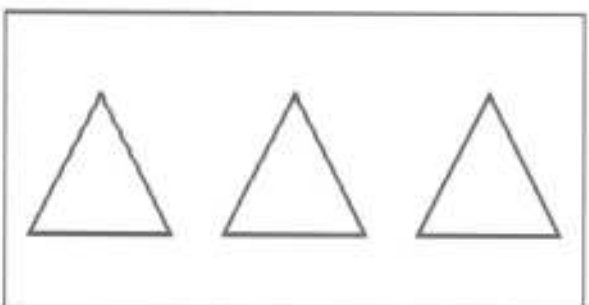
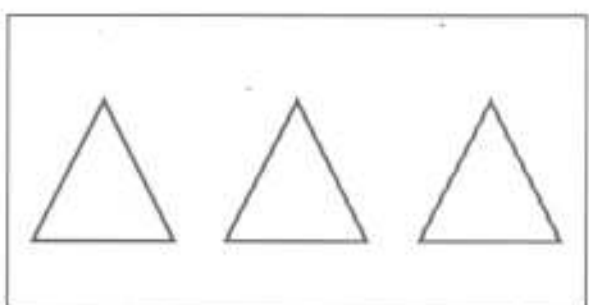
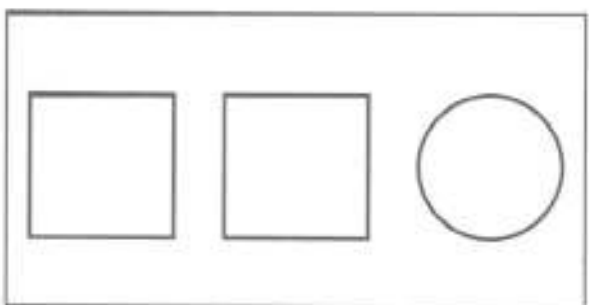
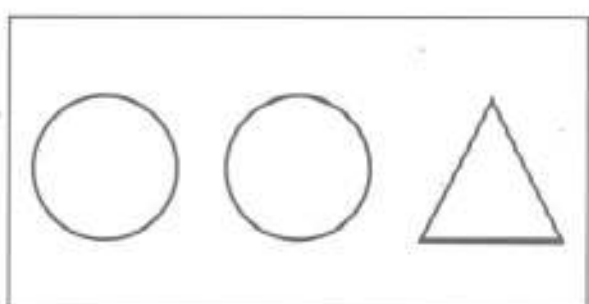
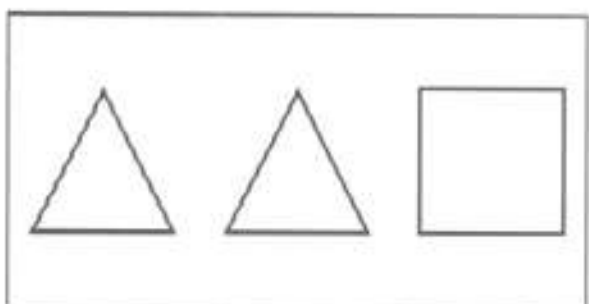
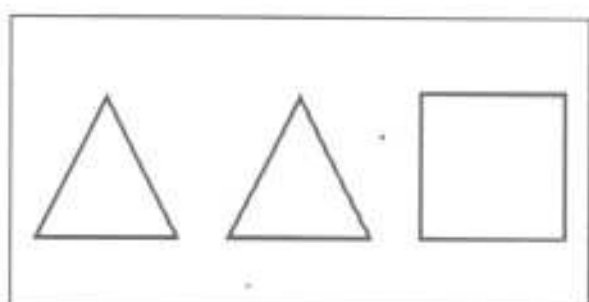
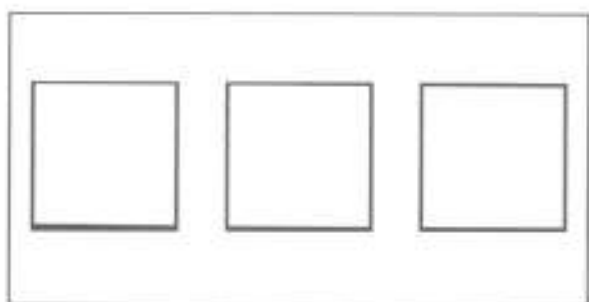
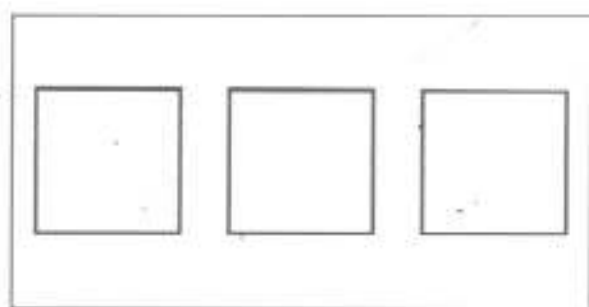
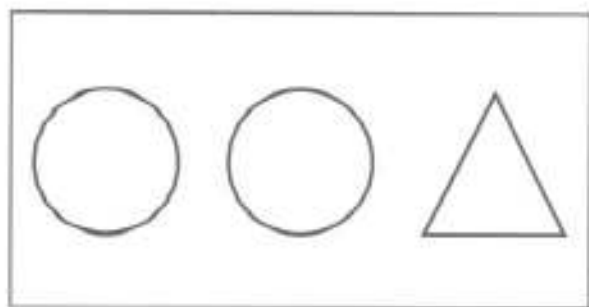

Colour and say.

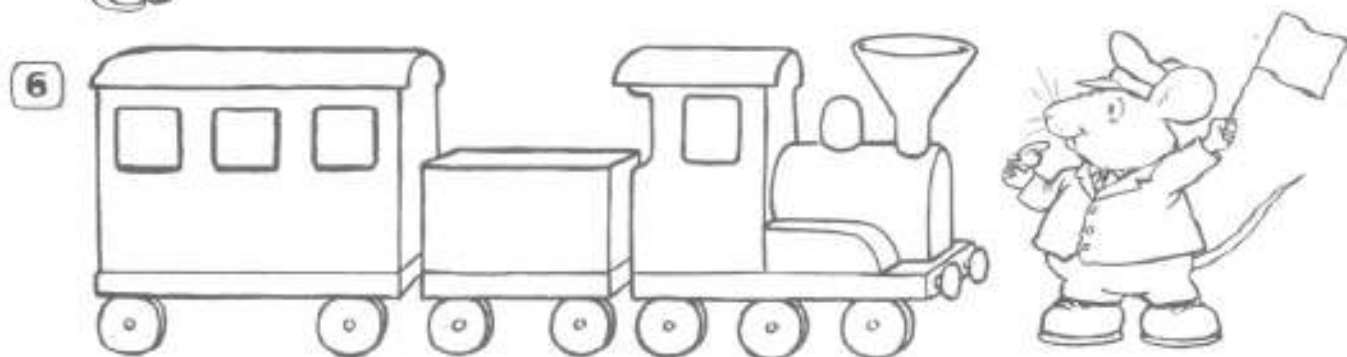
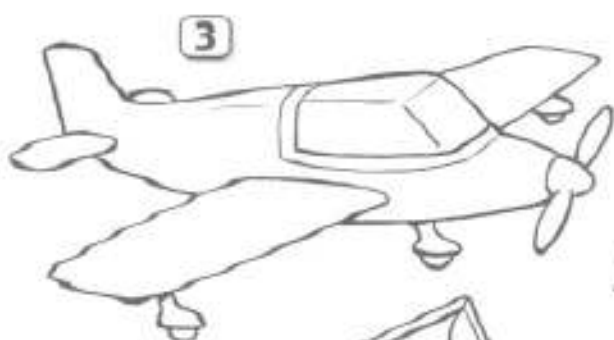
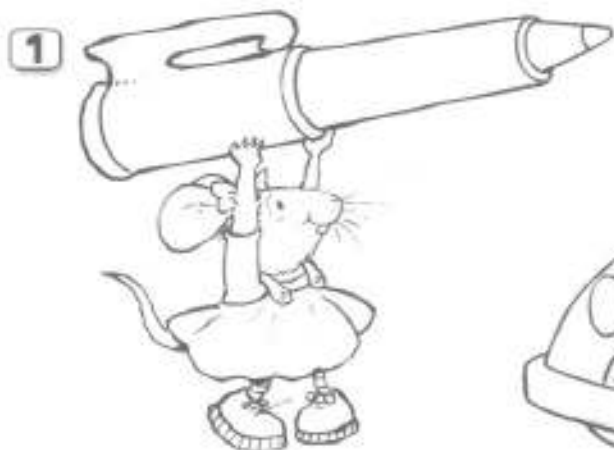

Find and draw.



Colour and say.

1



2



3



4



5



6



Colour and say.

1



2



3



4



5



6



Look and say.

1



2



3



4



Match and stick.

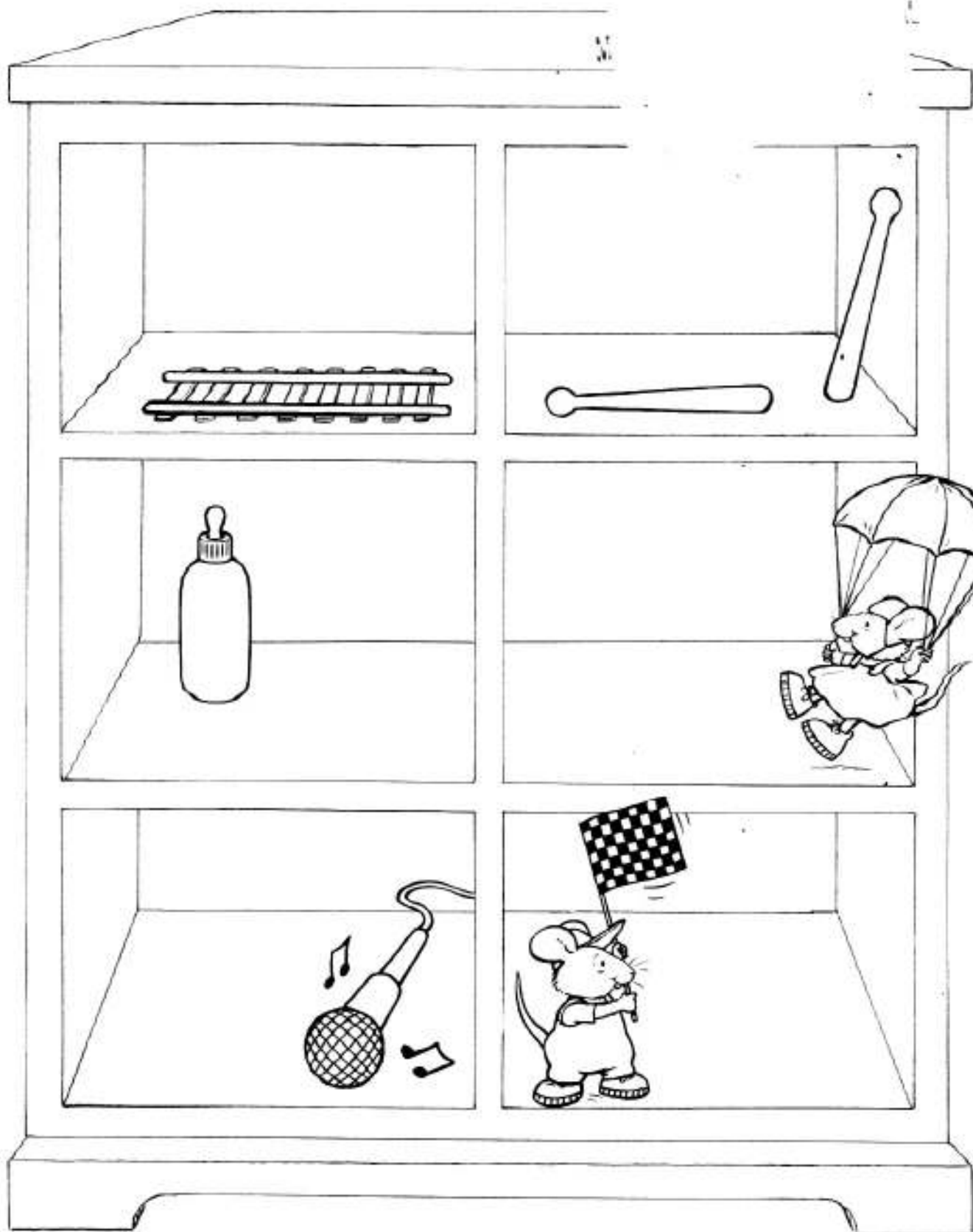

4 Dressing up

Look and say.



Now complete the picture.

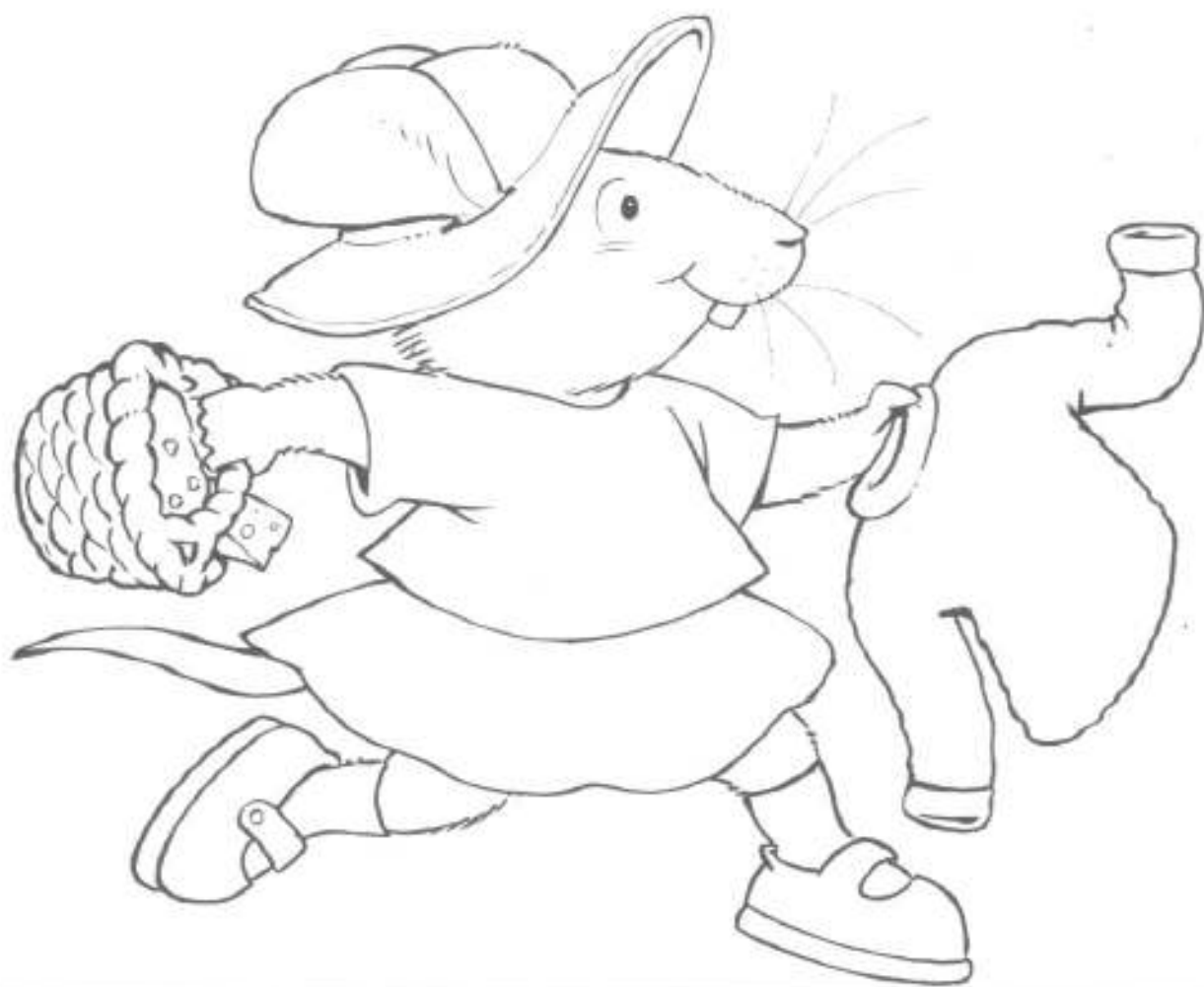

1 Listen and colour.

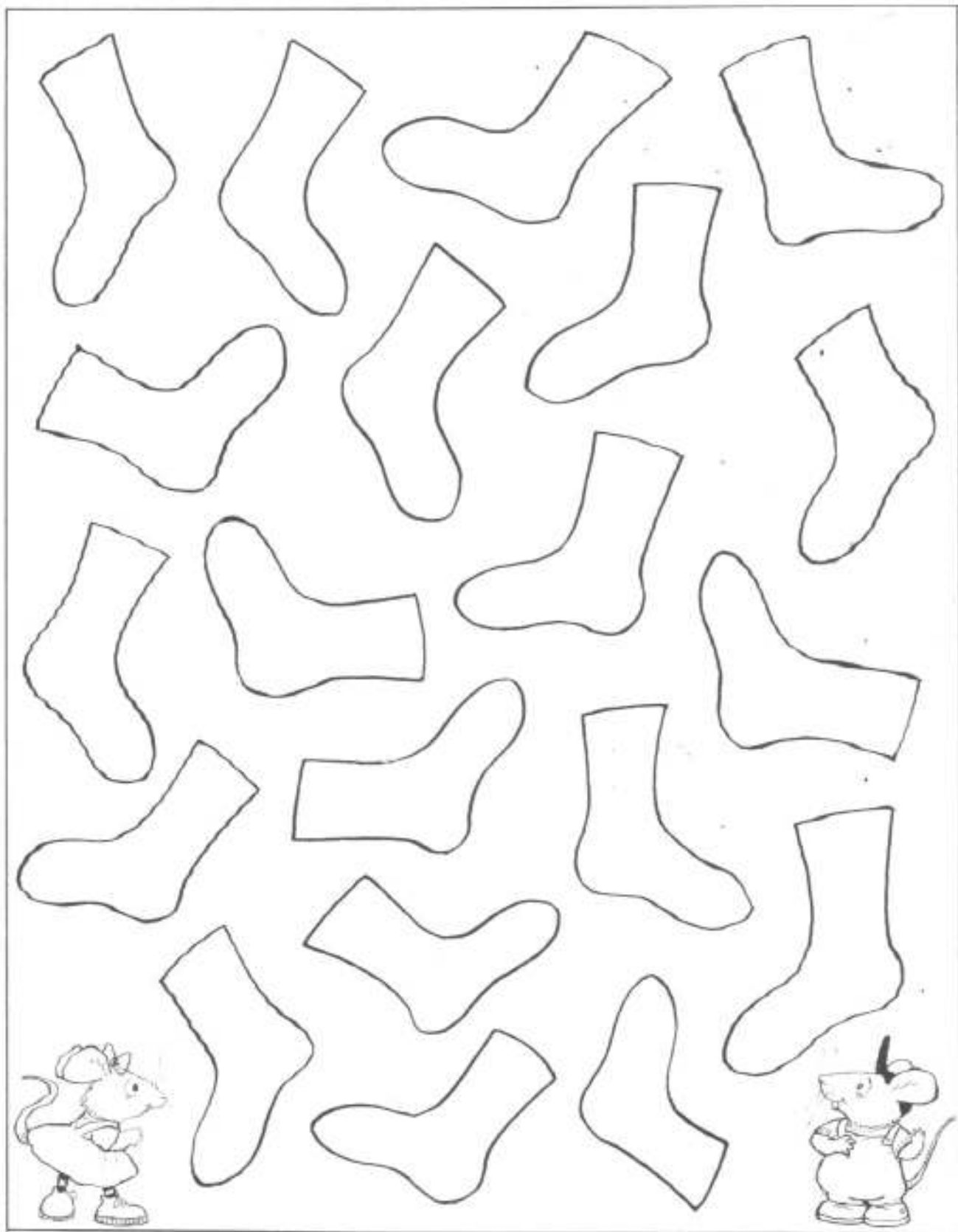

Draw and say.



Draw and colour your favourite T-shirt.

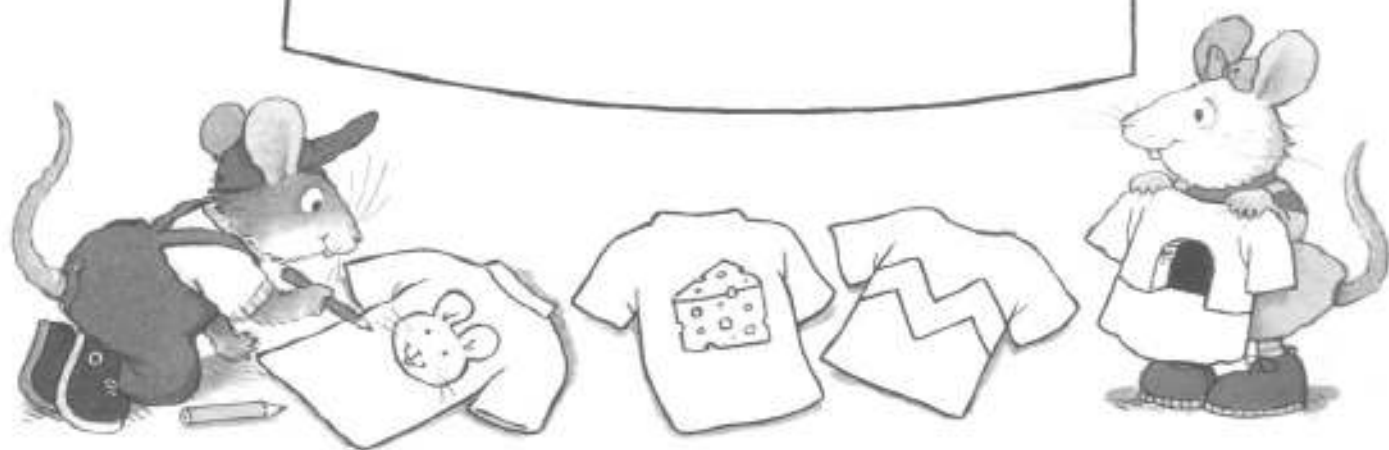
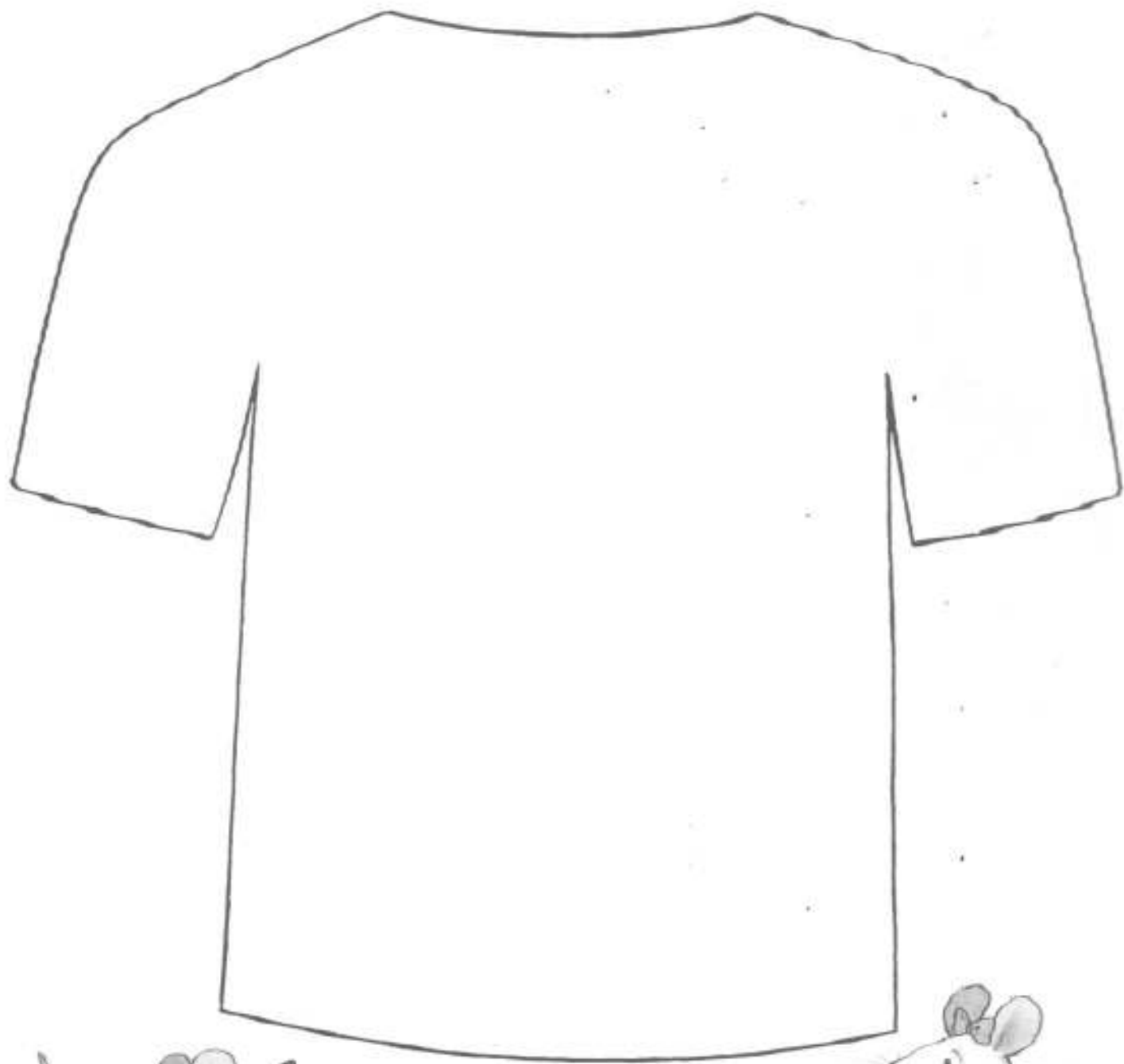

Colour.

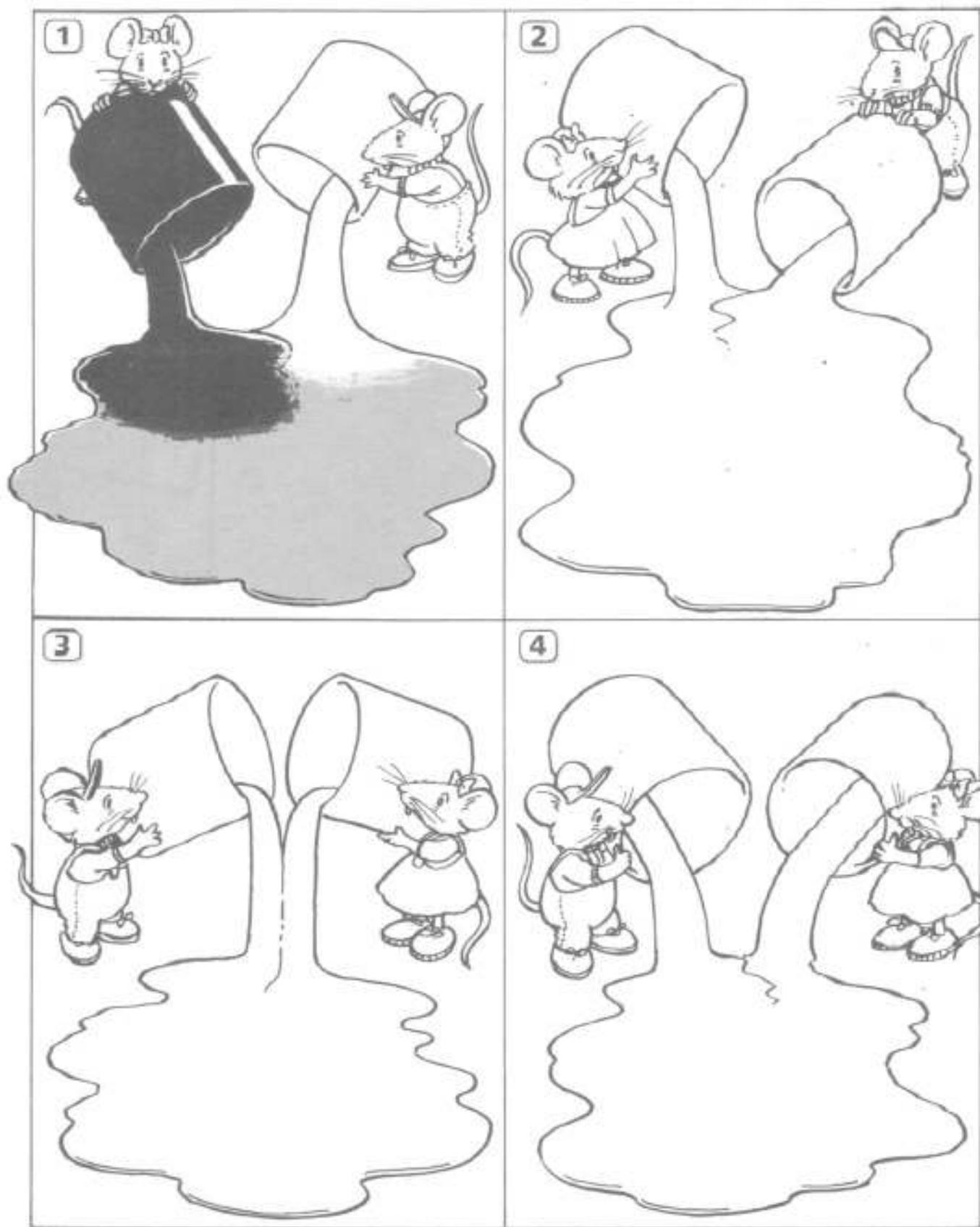

Colour, count and write the numbers.

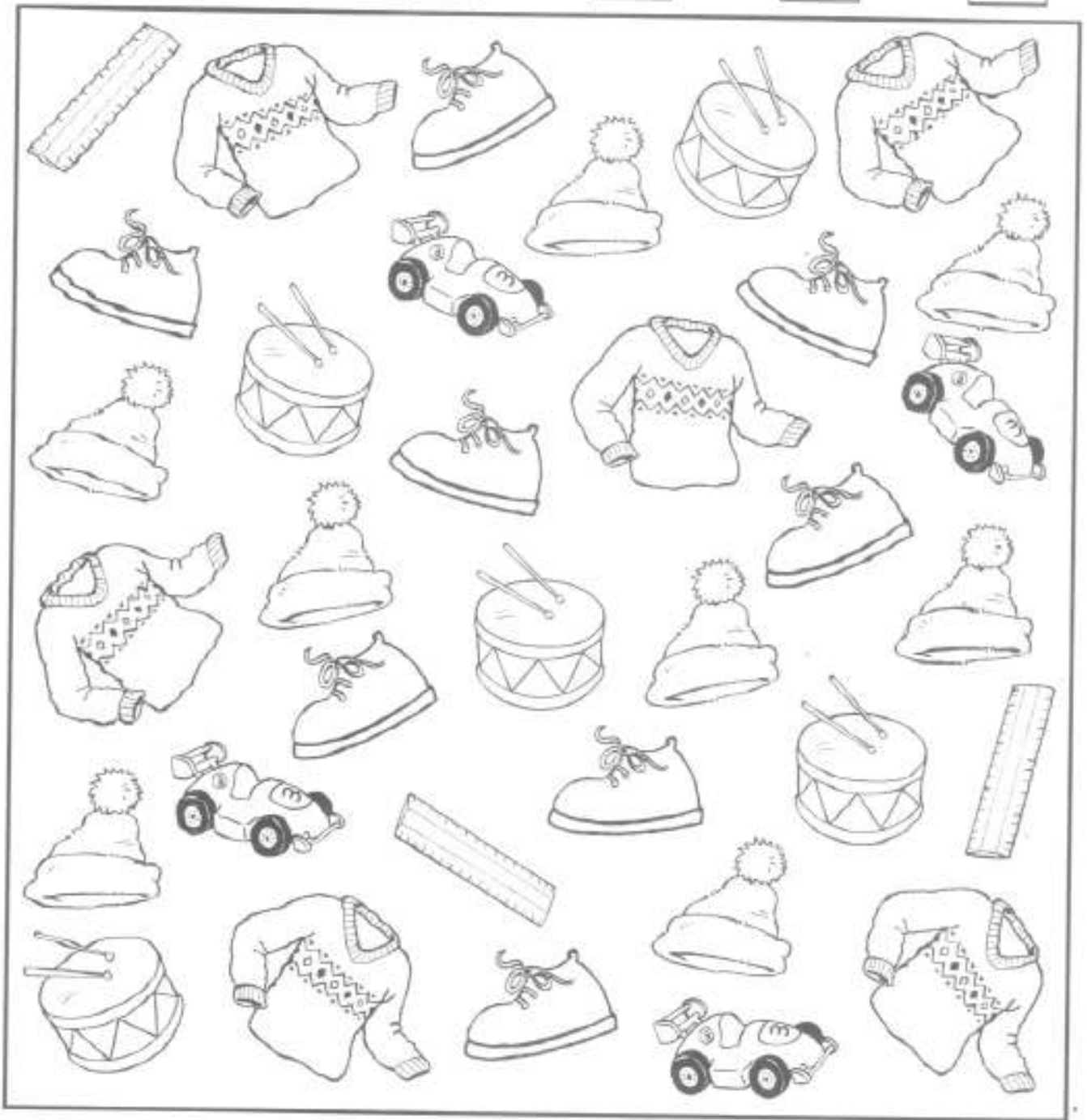
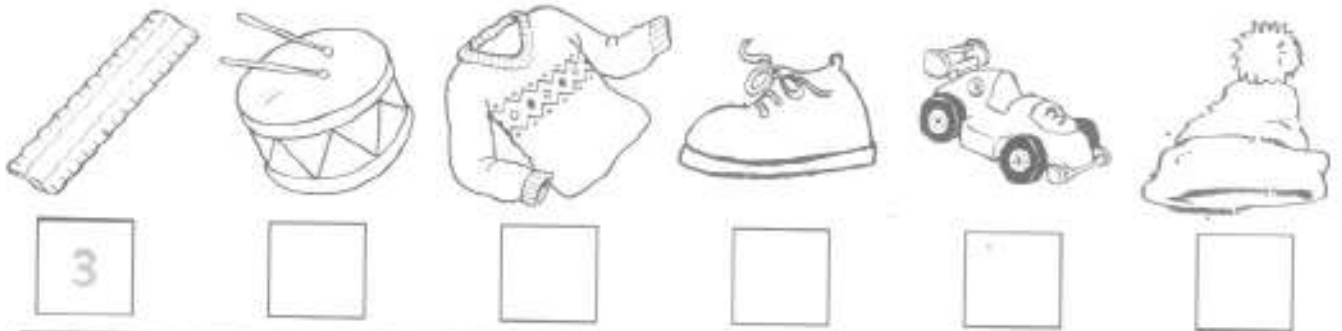

Find and draw.



Look and say.

1



2



3



4



5



6



1 Listen and colour.

1

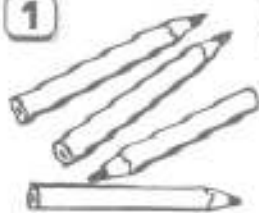

2



3



4



Look and say.

1



2



Match and stick.

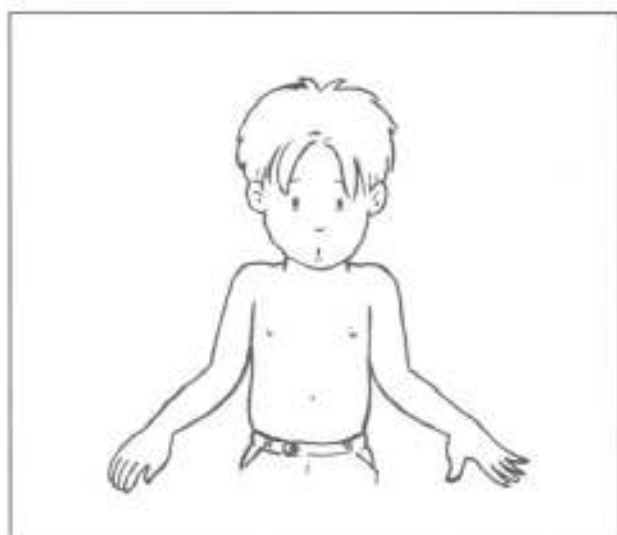
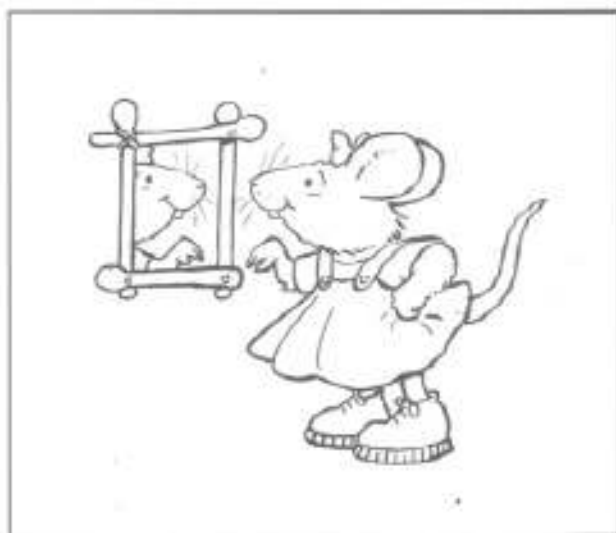
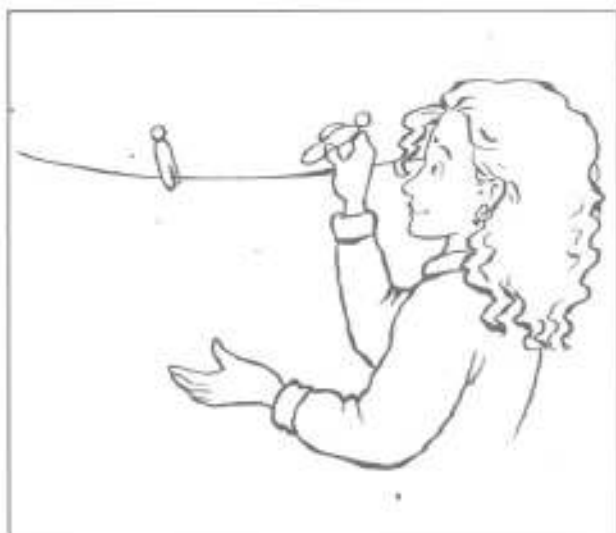

5 Happy birthday!

2 Listen and circle.

1



2



3



4



5

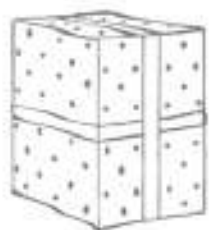

6

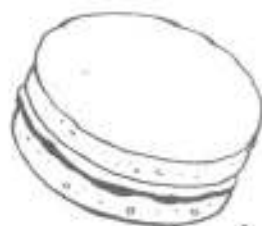

Choose and circle.

1

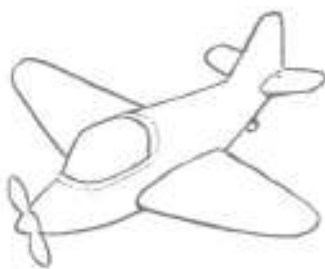

2

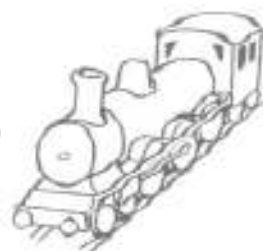

3

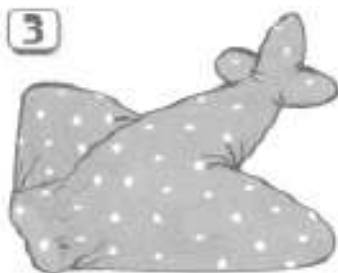

4



5



2 Listen and ✓ for yes or X for no.

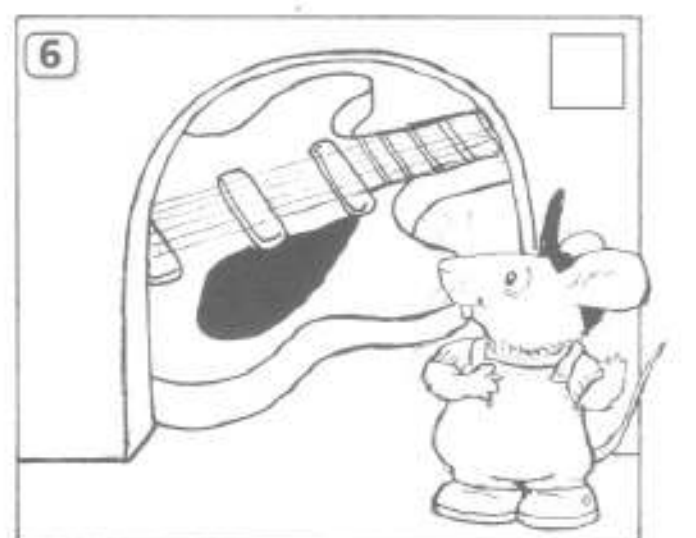
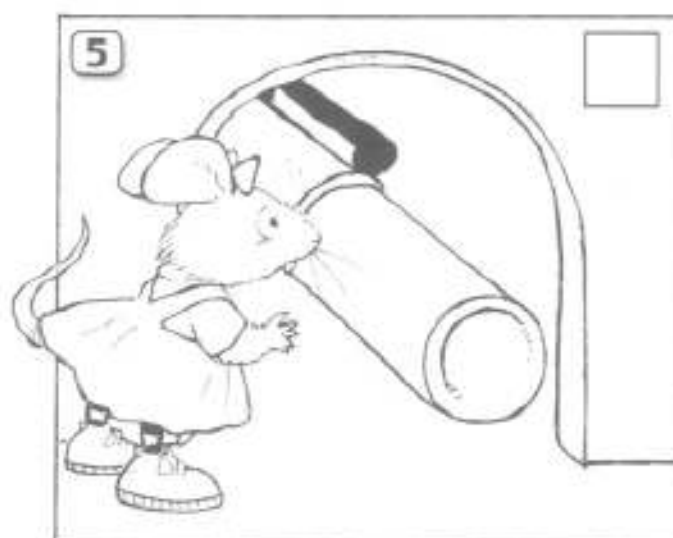
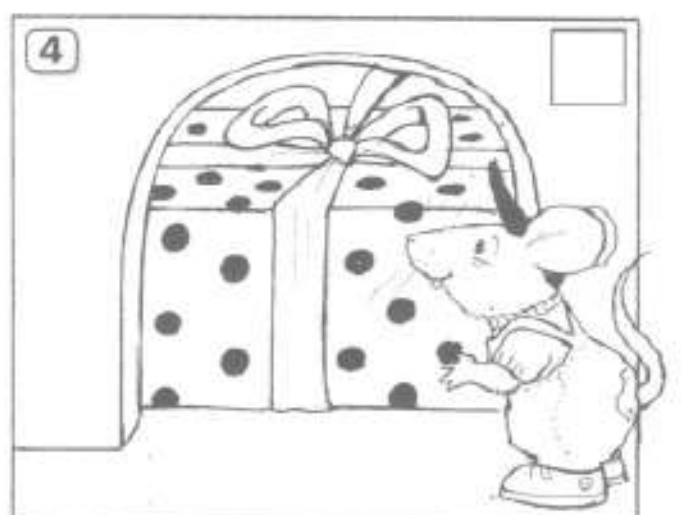
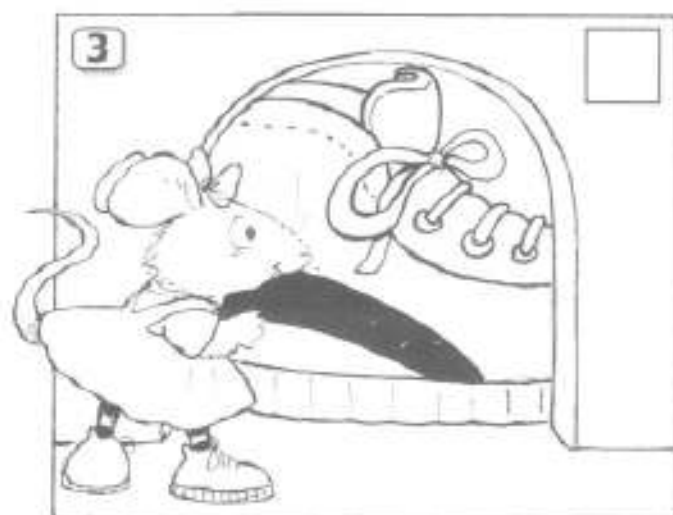
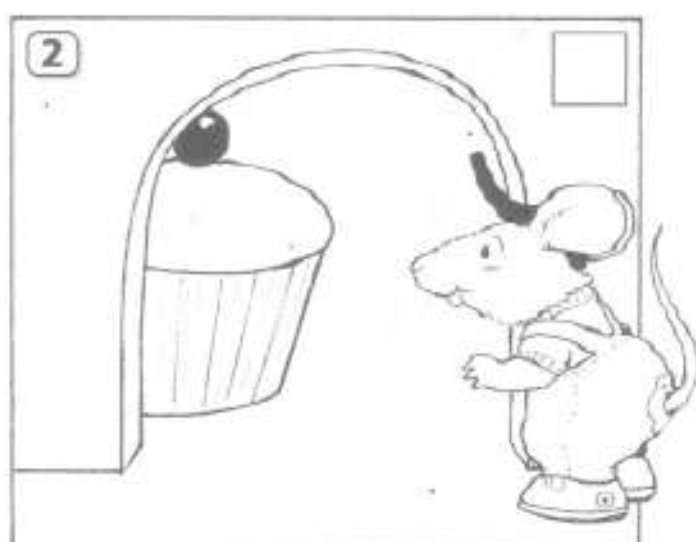
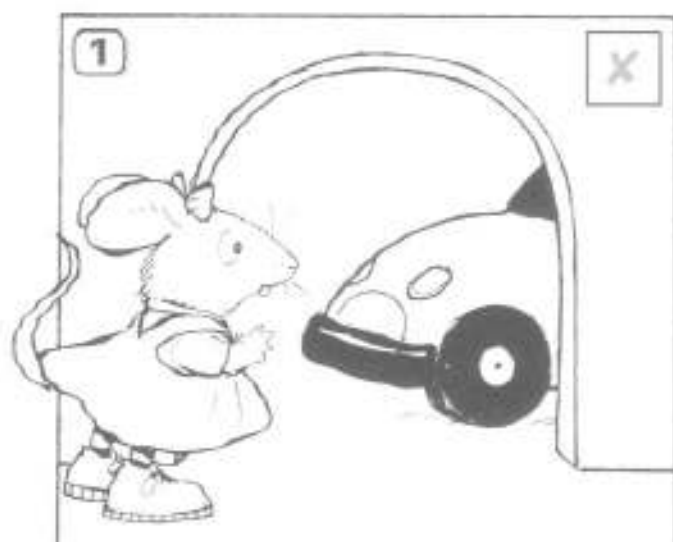

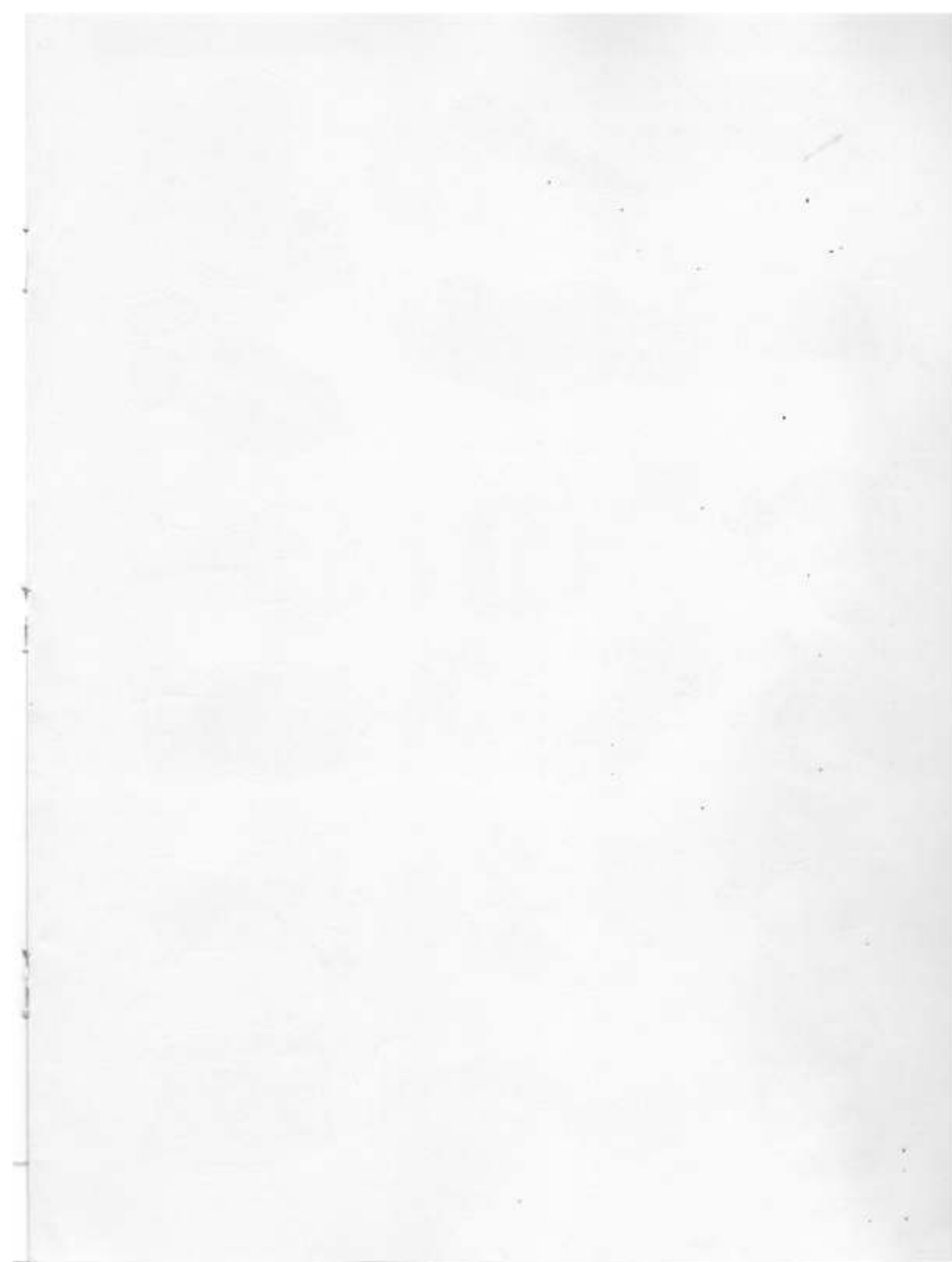

Unit 1



Unit 2

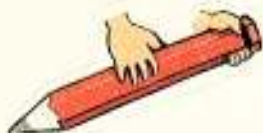
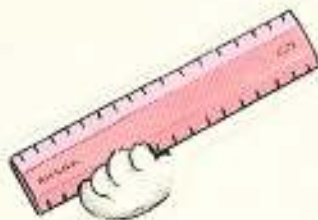
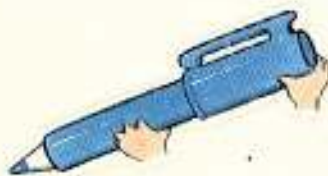

Unit 3

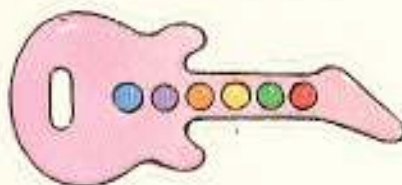

Unit 4



Unit 5

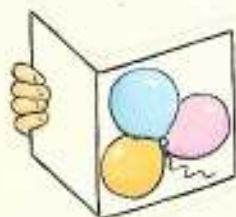

Unit 6



Unit 7

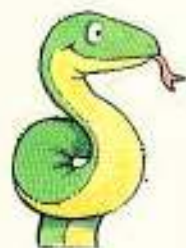
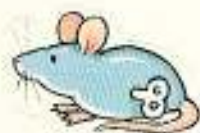

Draw and say.

About me!

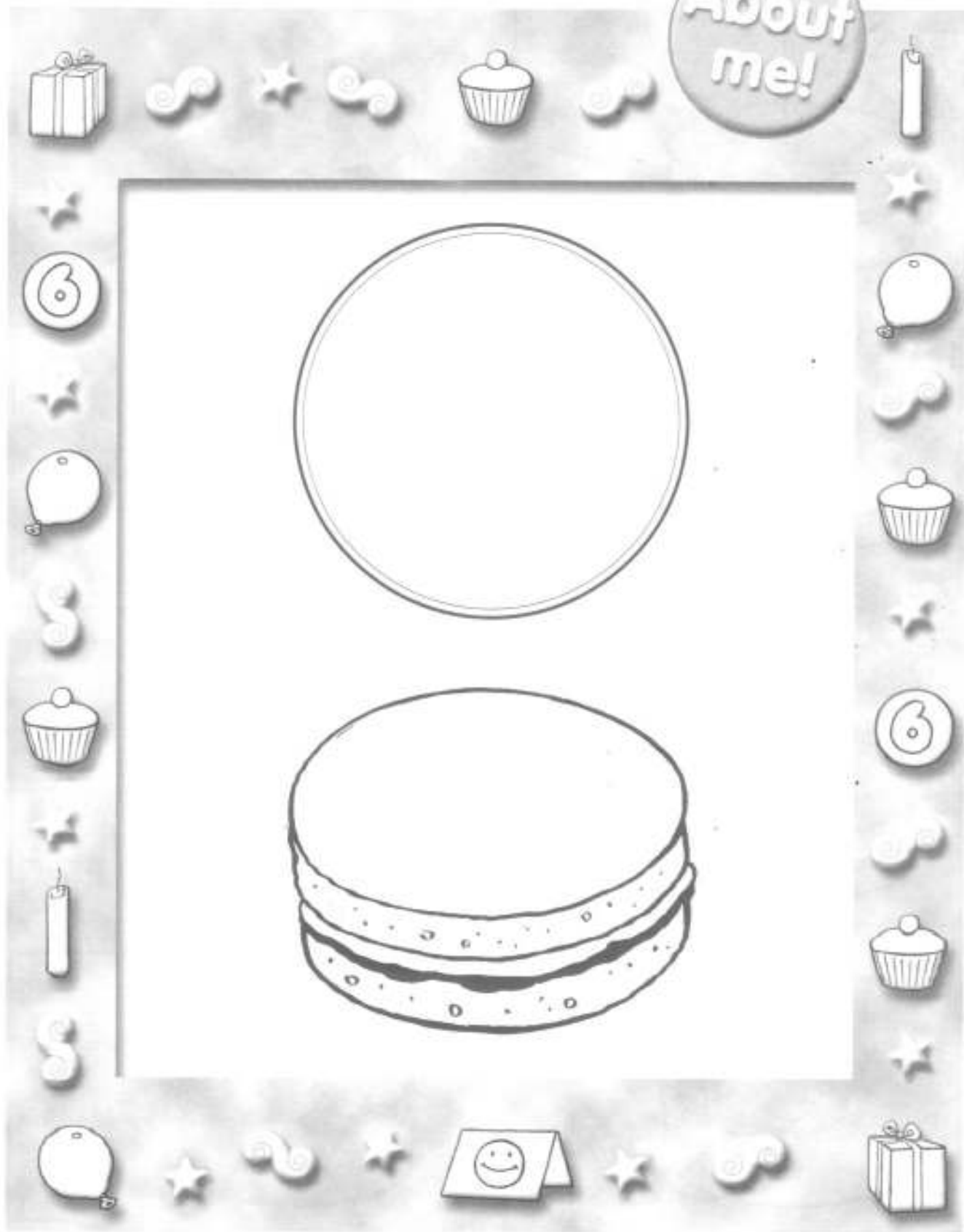



Draw the candles and write the numbers.

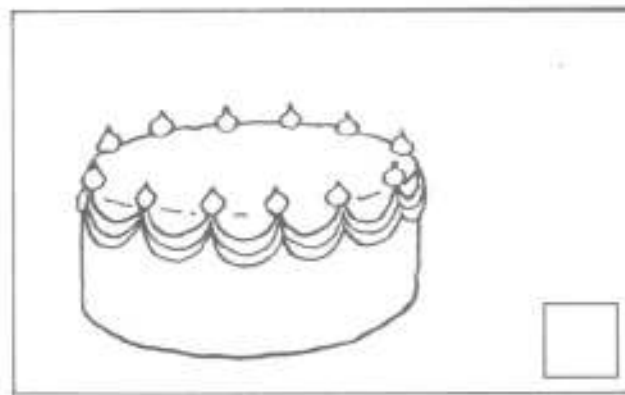
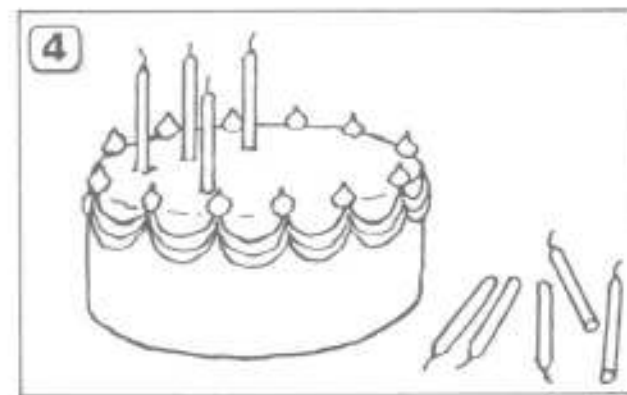
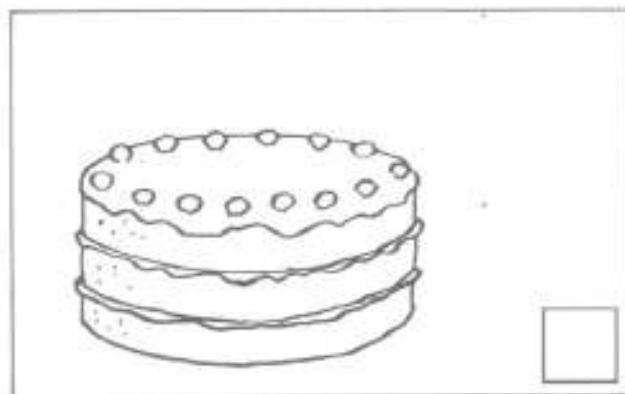
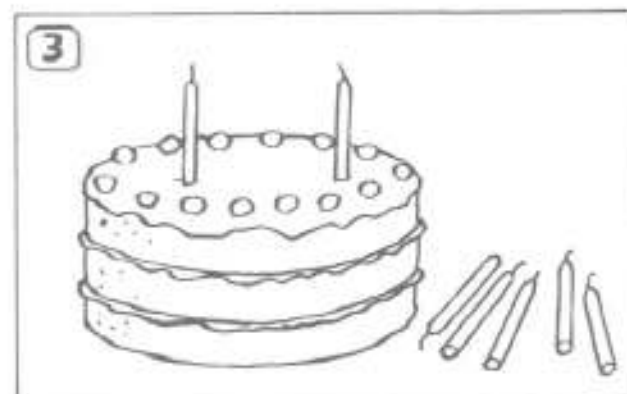
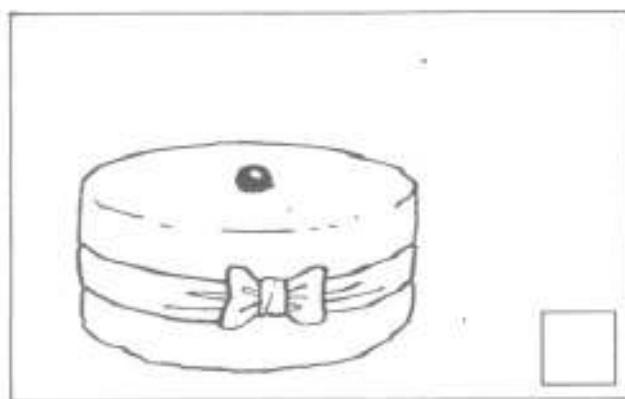
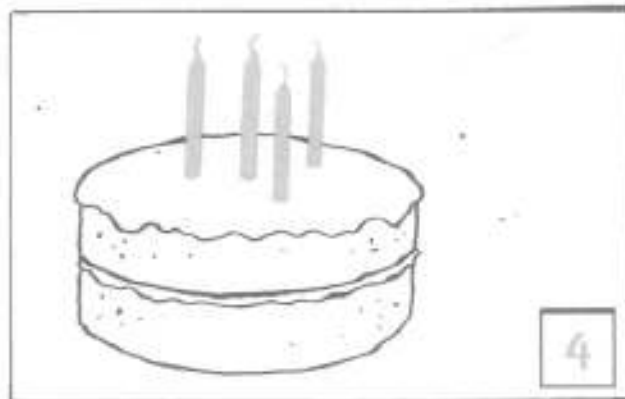

2¹⁴ Listen and write the numbers.

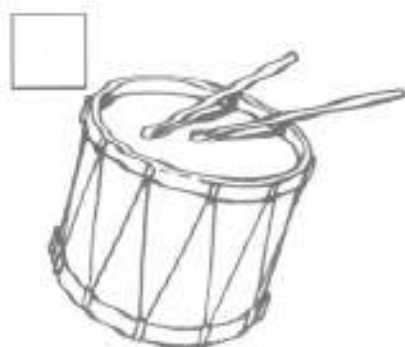
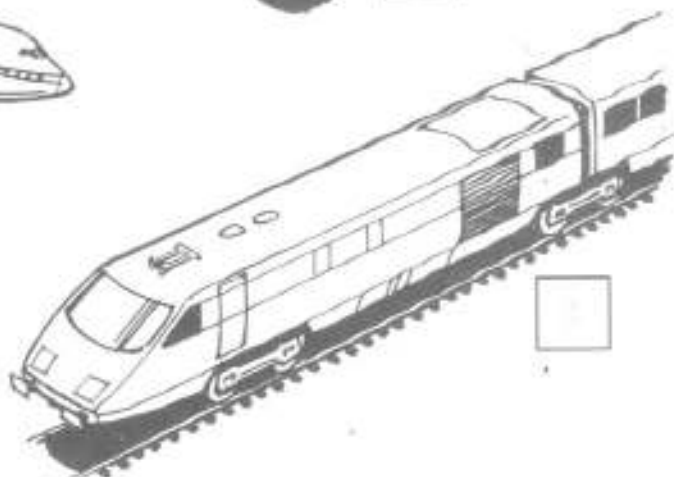
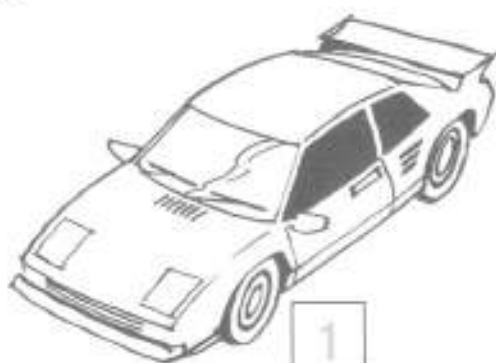
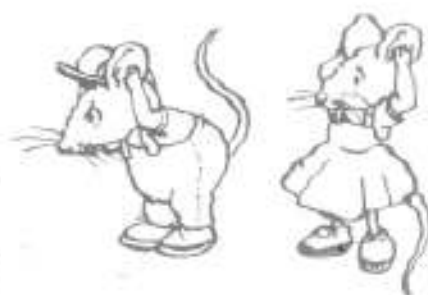

Find and draw.



Look and say.

1



2



3



4



5



6



2 Listen and ✓ or X.

1



2



3



4



5



6



Look and say.

1



2



3



Match and stick.

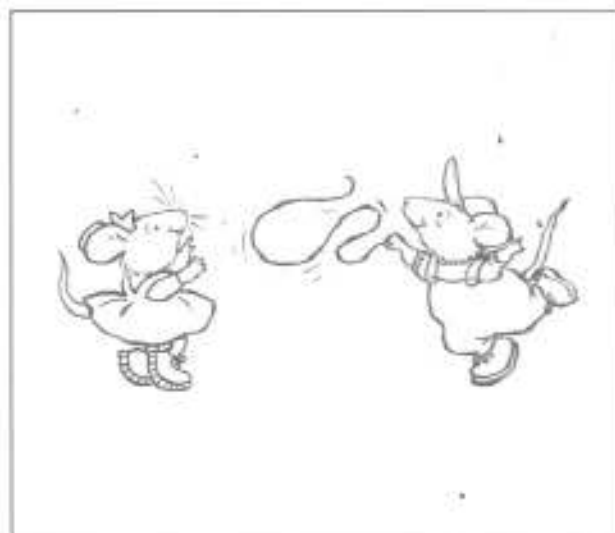
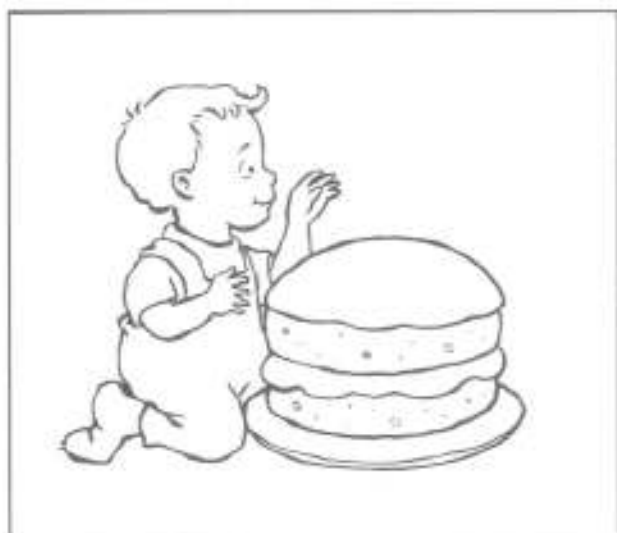

6

Bathtime!

2 Listen and colour.

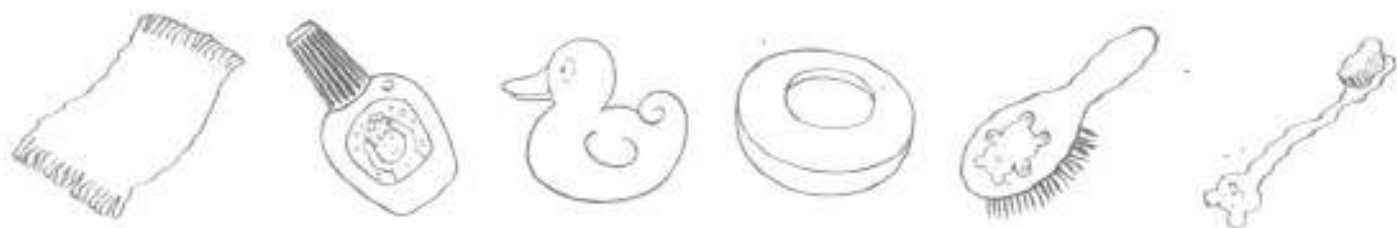

Now look, find and colour.



In your classroom, can you see a ...? ✓ or ✗.

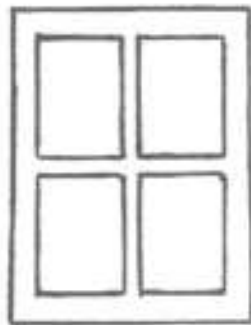
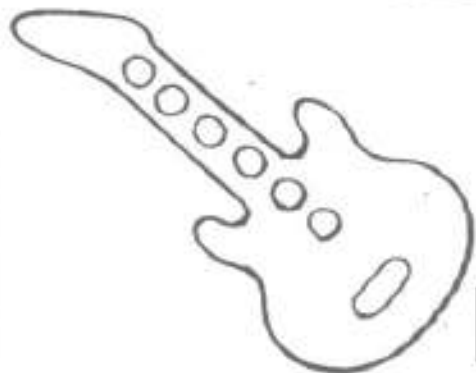
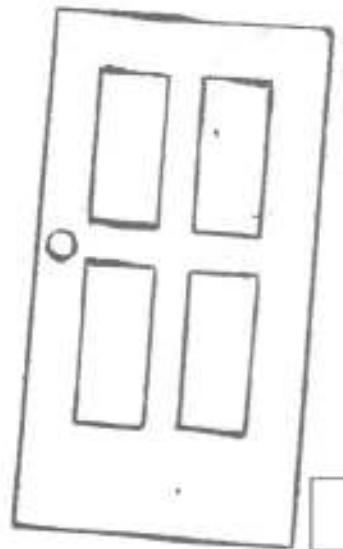

Draw and say.



Listen and write the numbers.

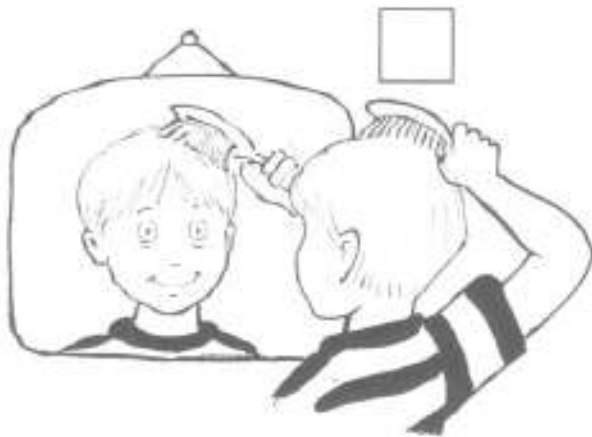

Colour the  red for hot, blue for cold or purple for warm.

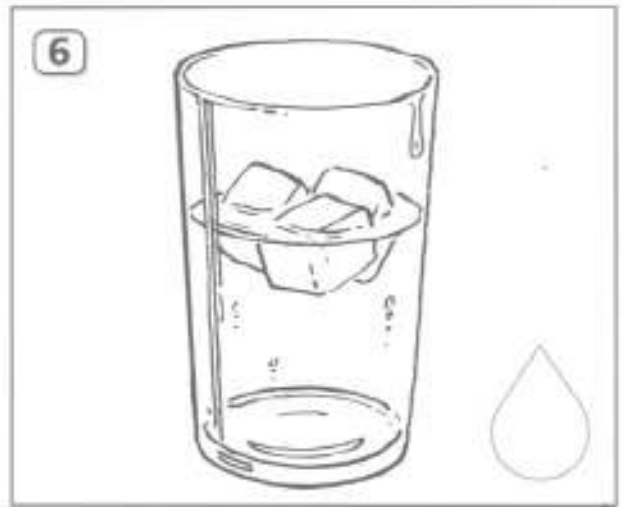
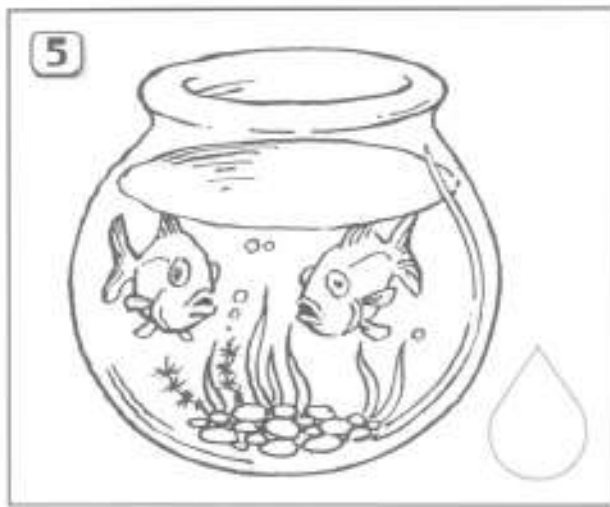
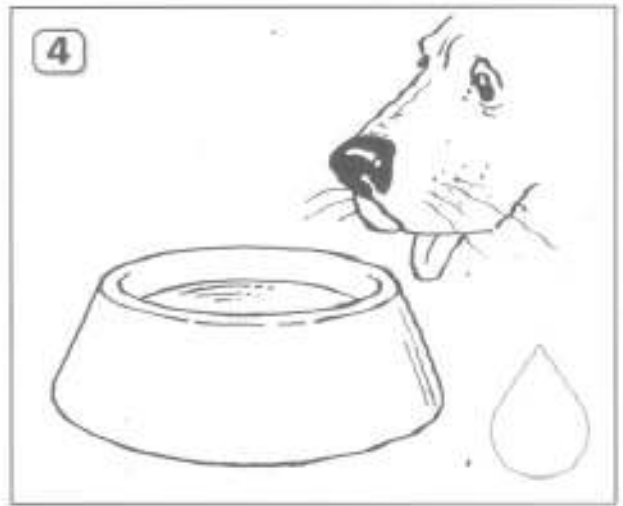
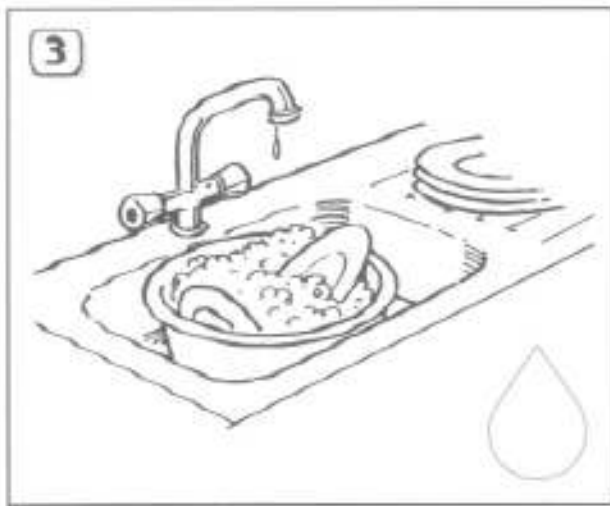
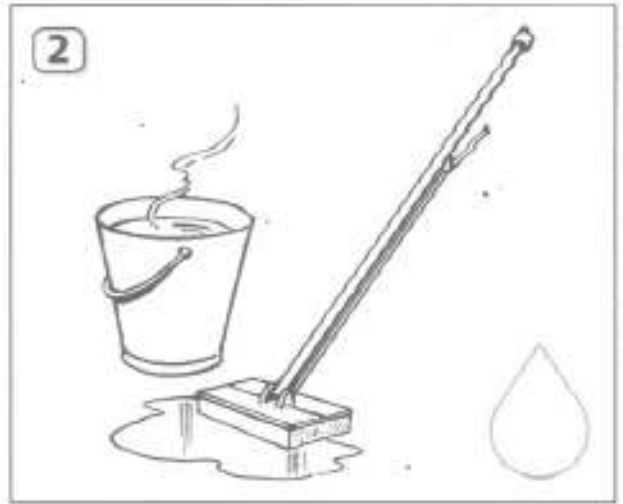

Match and say.

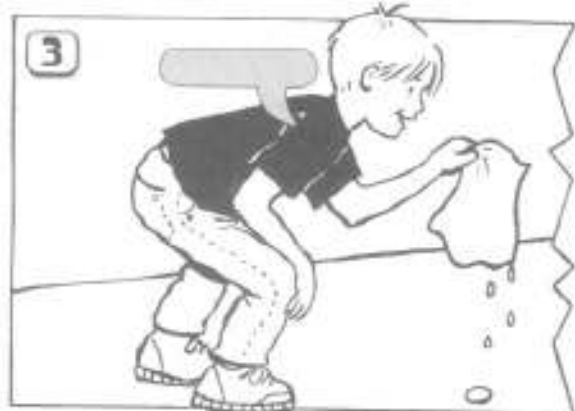

Find and draw.



Look and say.

1



2



3



4



5



6



2 Listen and write the numbers.



Look and say.

1

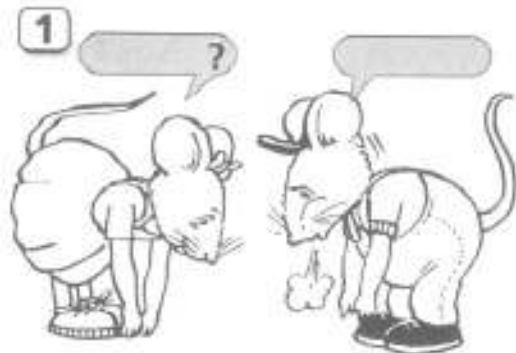

2

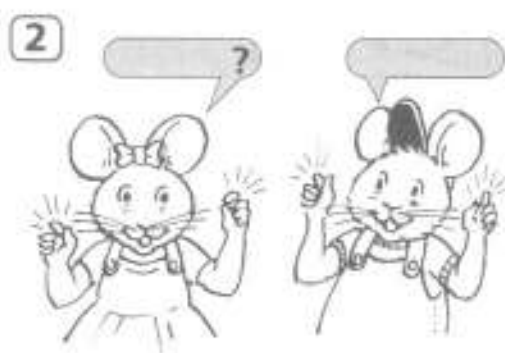

Match and stick.

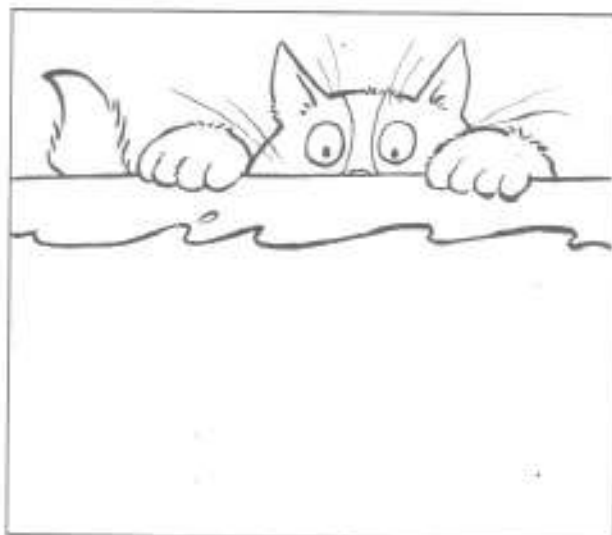
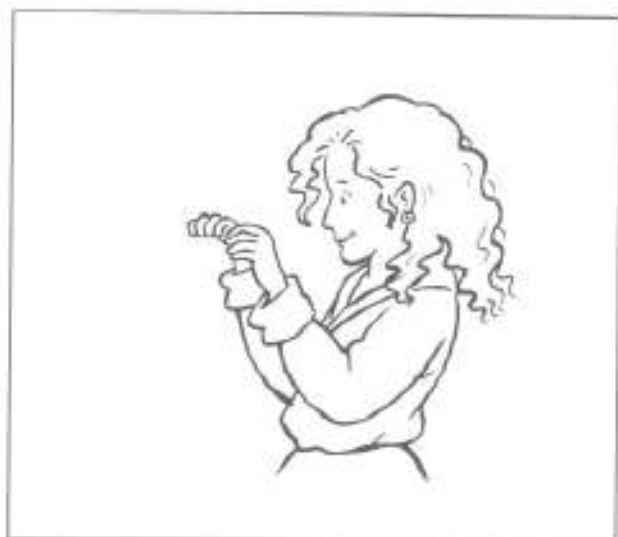

7

Animal friends

Look and say.

1



2



3



4



5



6



Now draw the tails.

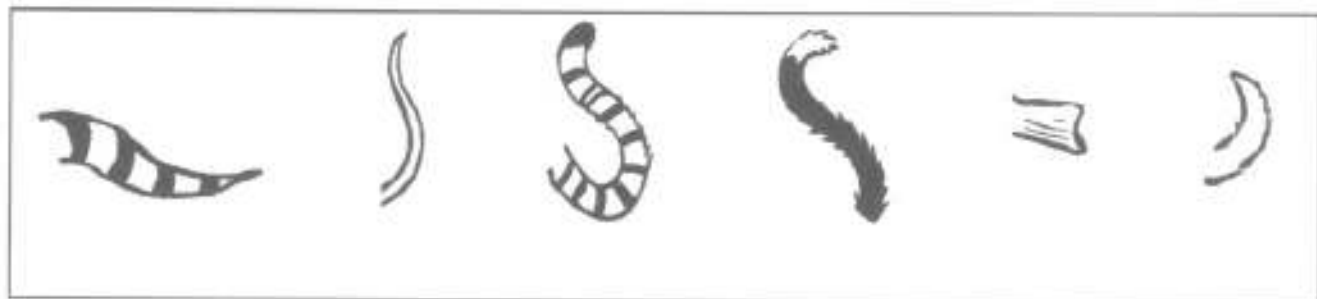

Look and draw.

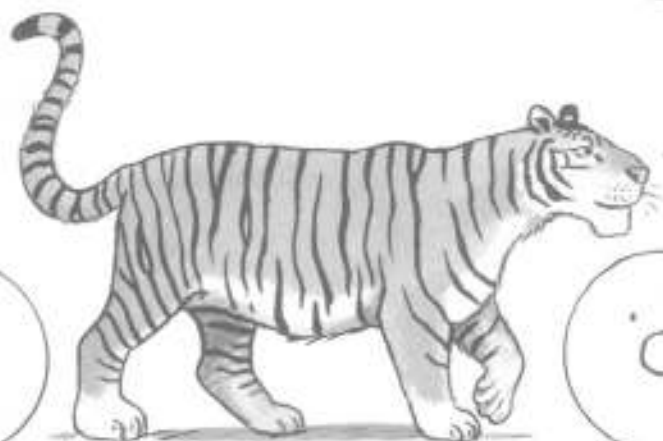

Draw and say.

About
me!

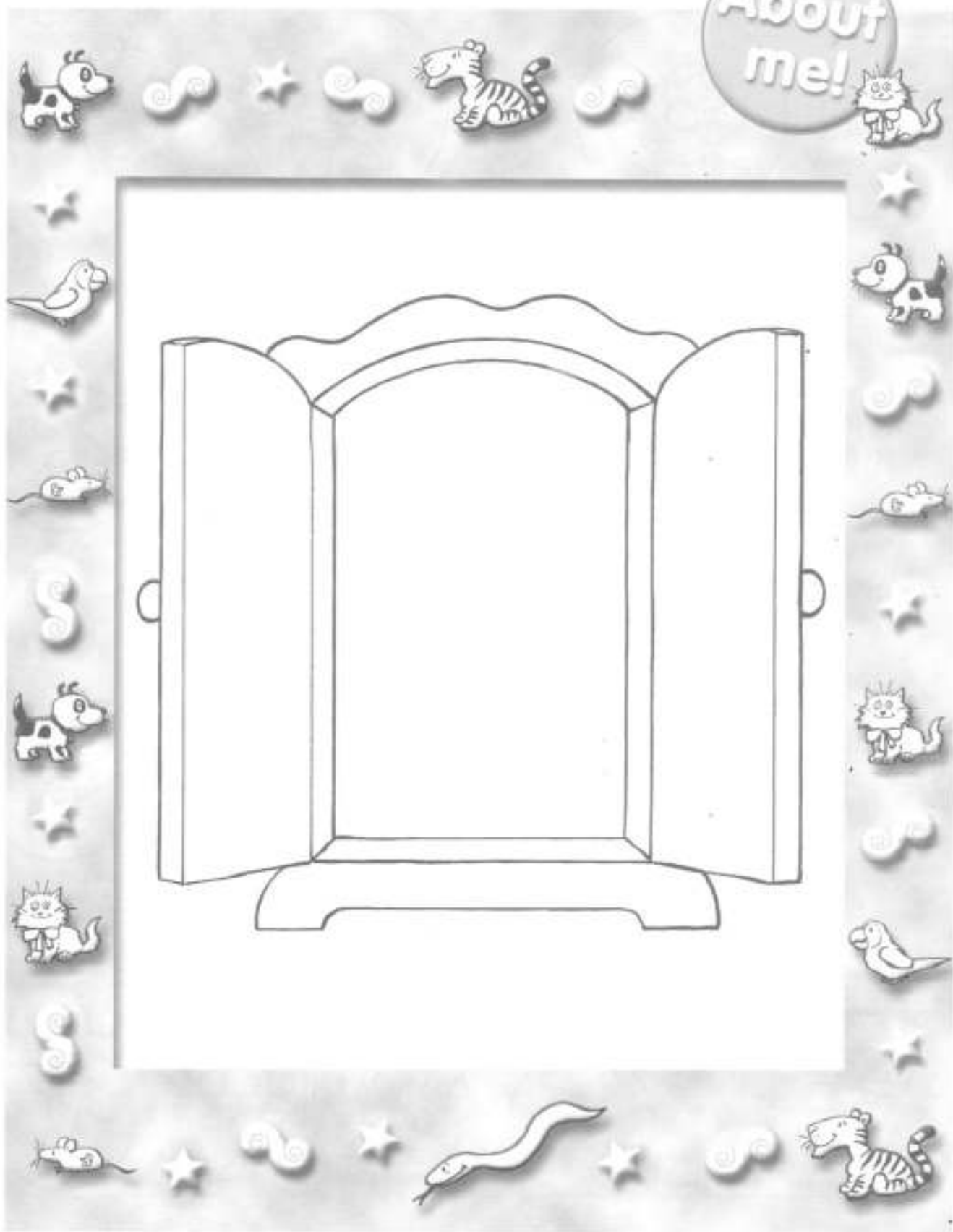

2⁴⁴ Listen and write the numbers.

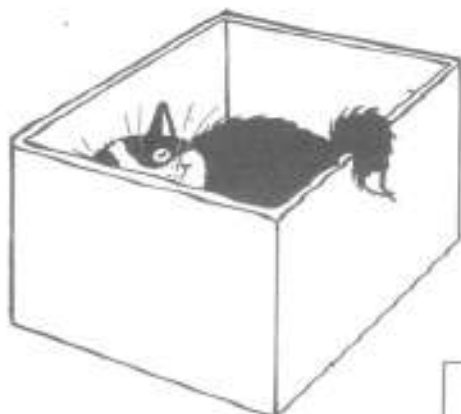
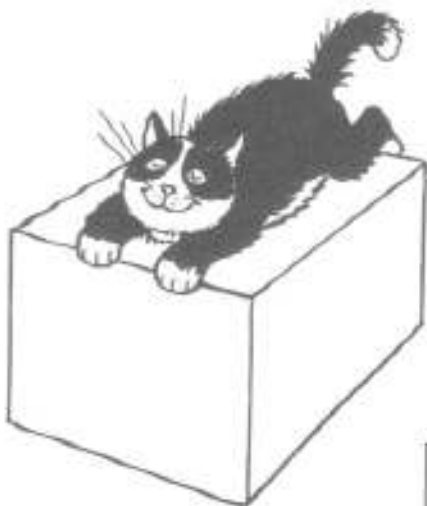
 1

Look and match.

1



2

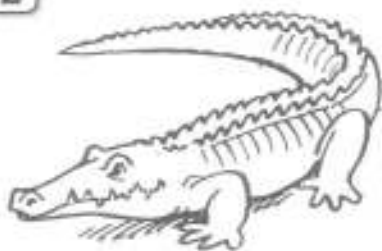

3

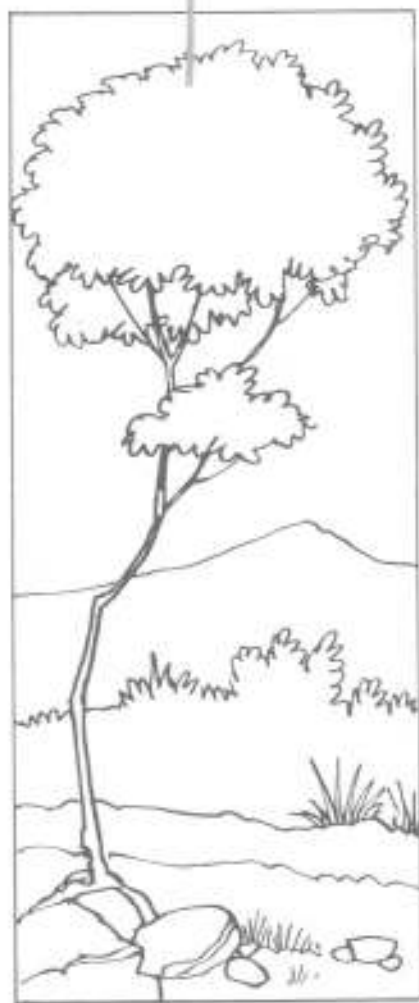
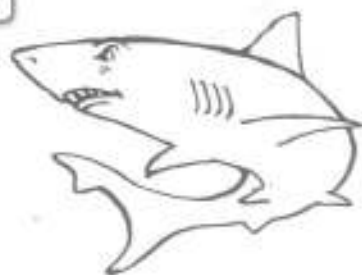

4

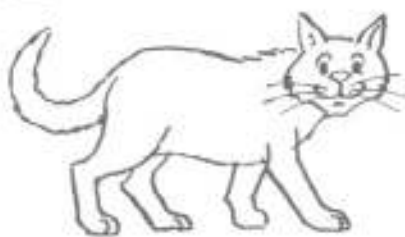

5

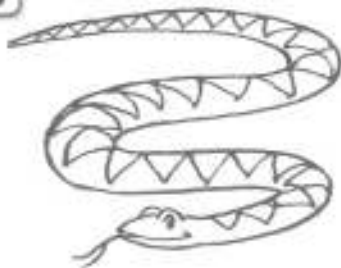

6

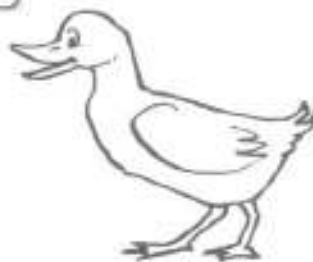

2 ⁴⁹ Listen and circle.



1



2



3



4



5



6



Find and draw.



Look and say.

1



2



3



4



5



6



Look and say.

1



2



3



4



Look and say.

1

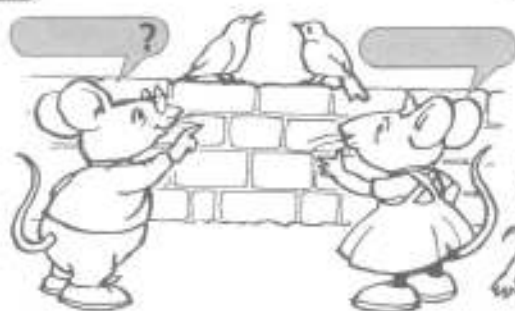

2

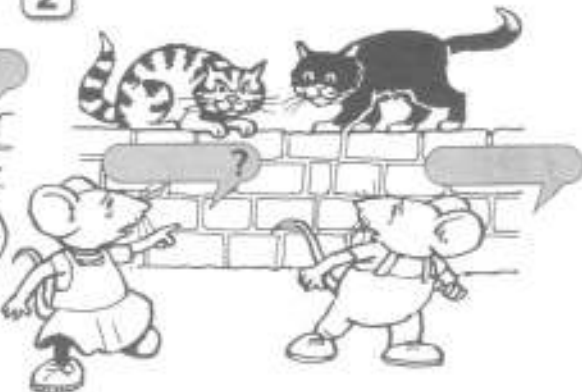

Match and stick.

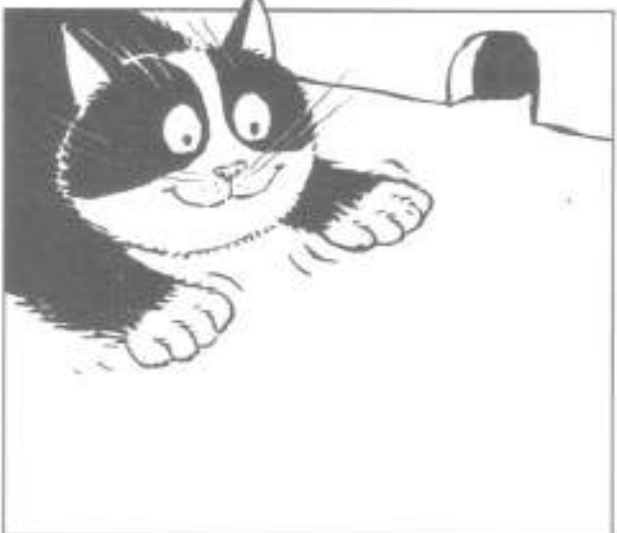
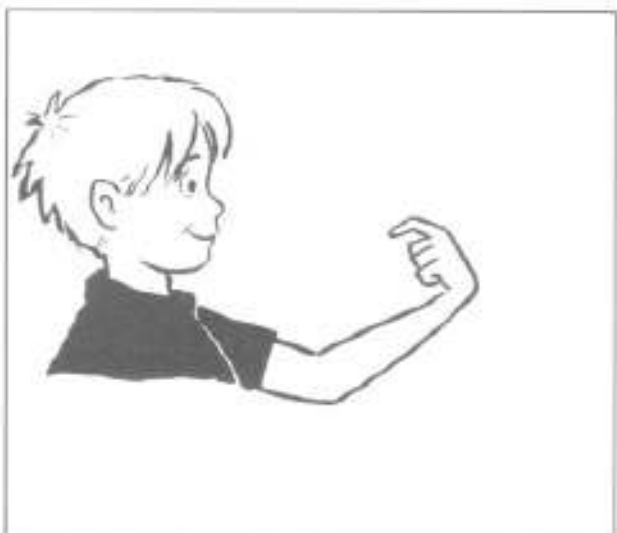
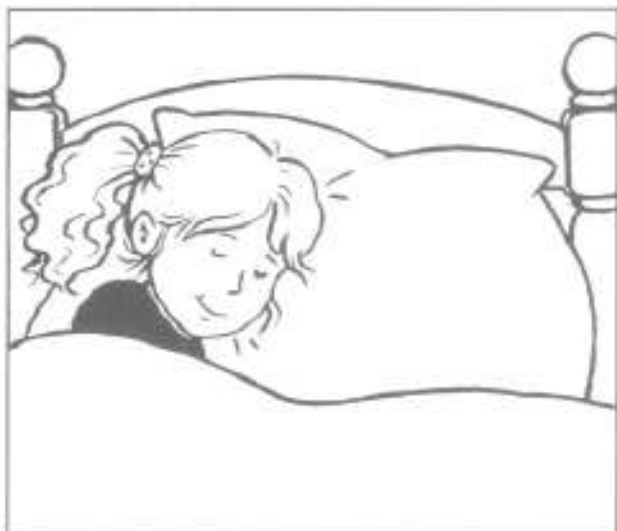

Revision

Find, colour and ✓.



✂ Make a house. --- = cut — = fold

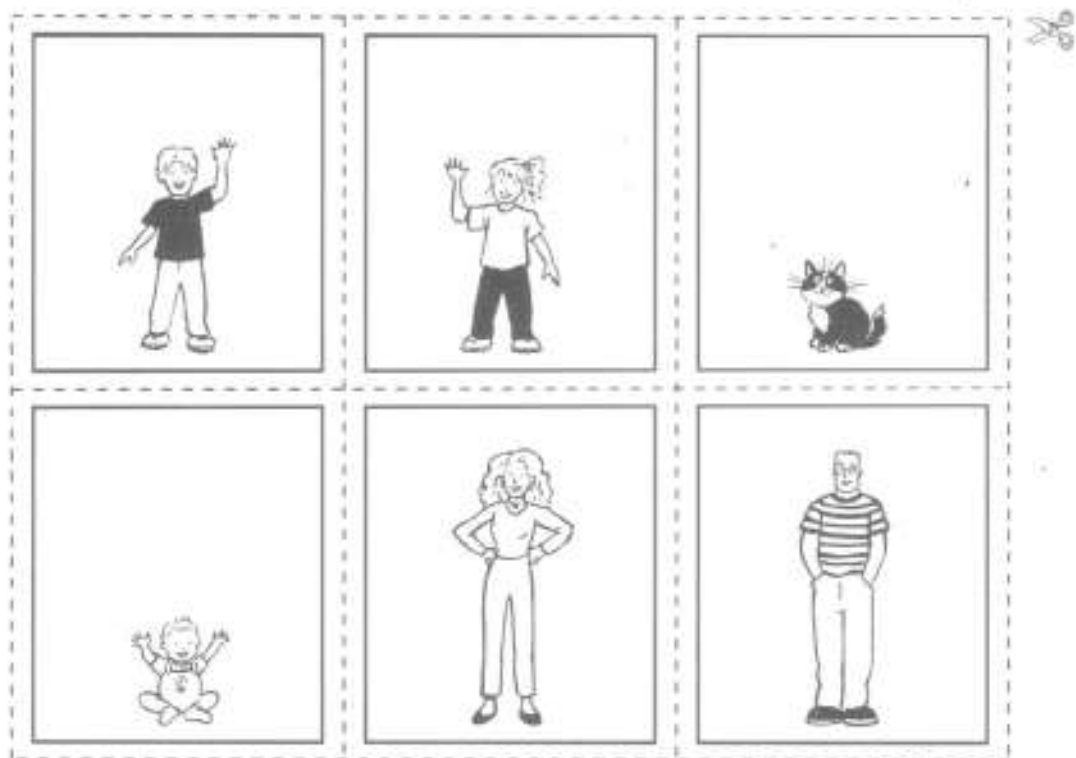

Unit 1 Lesson 7 cut-out



--- = cut



✂ Make and play number pairs. --- = cut

1

2

3

4

5

6

7

8

9

10

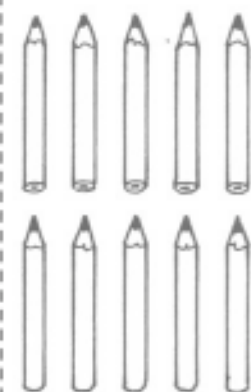
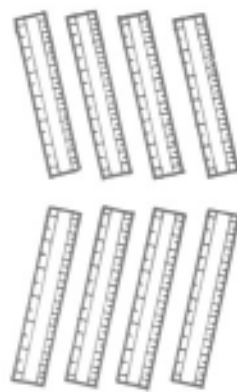
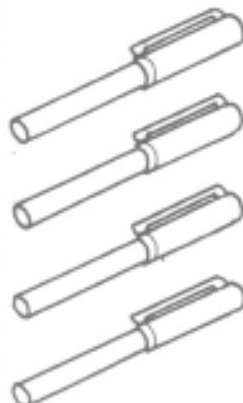
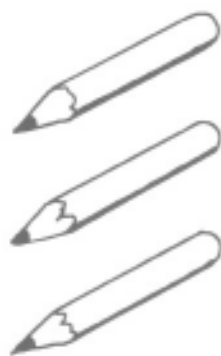

--- = cut



✂ Make colour spinners. --- = cut ✂ = glue

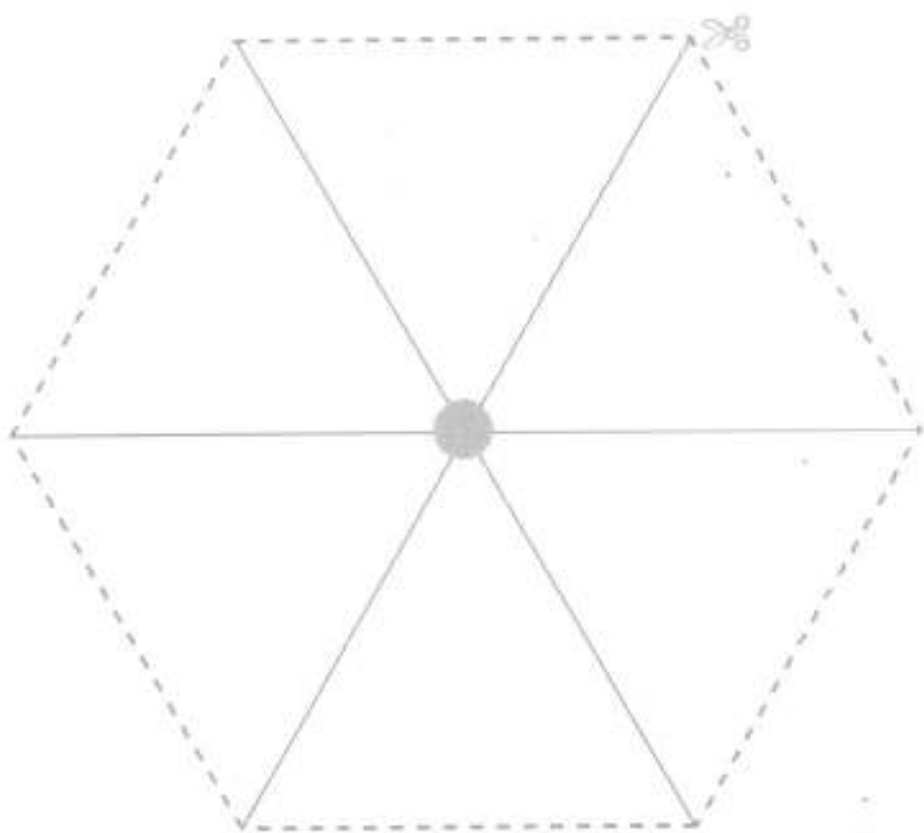
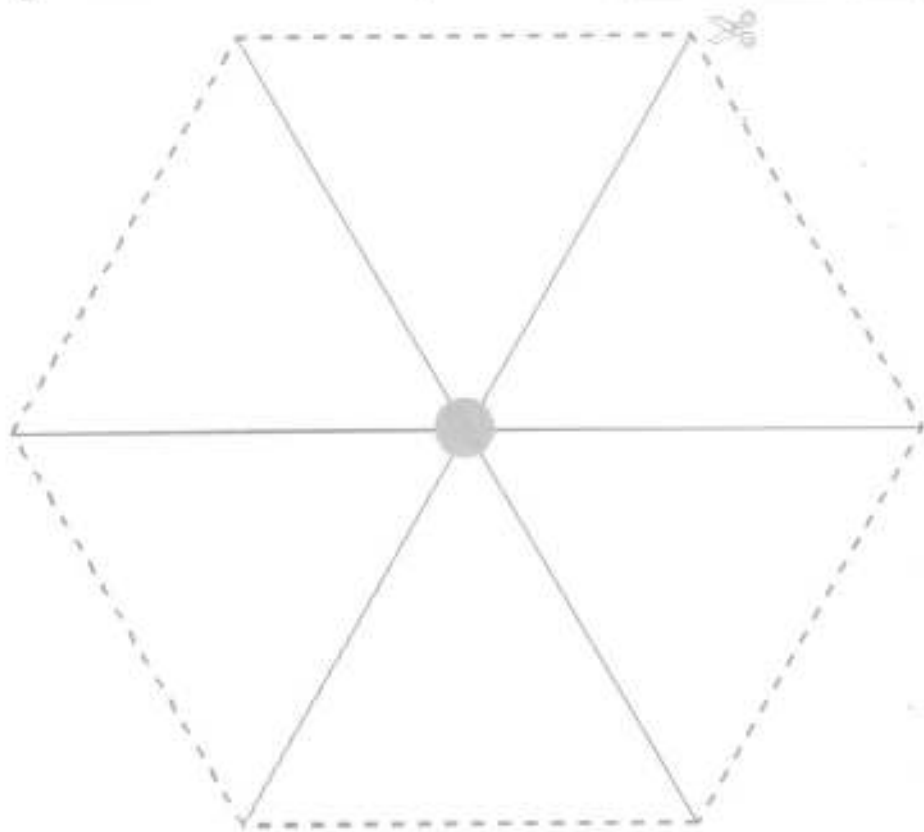

--- = cut  = glue

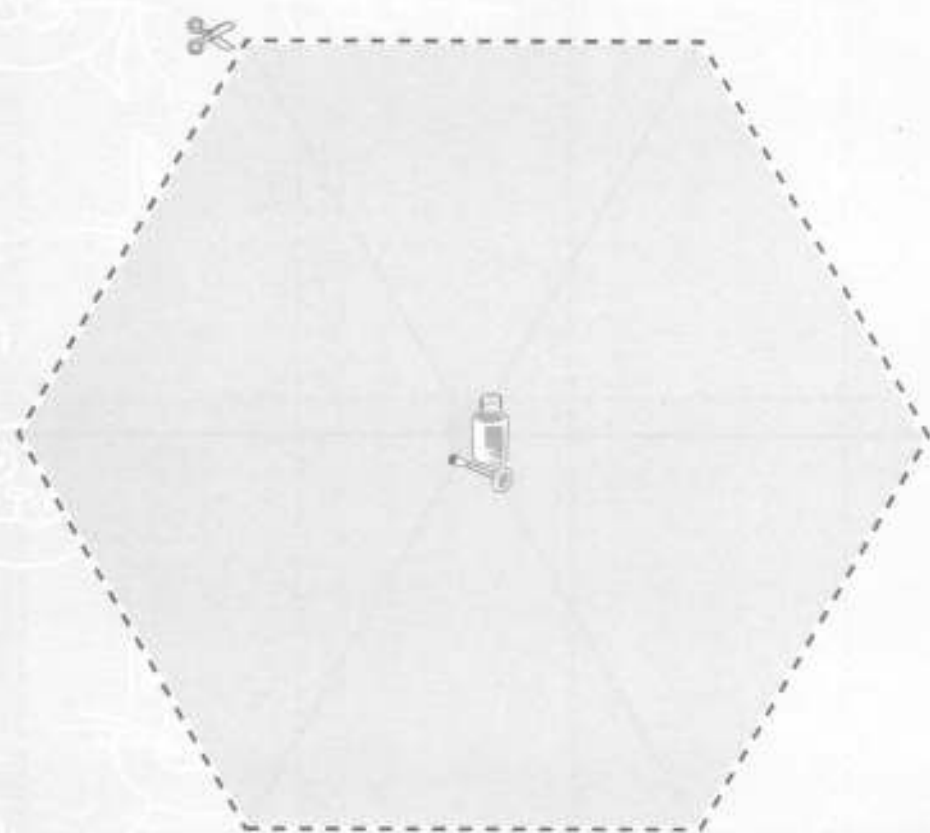
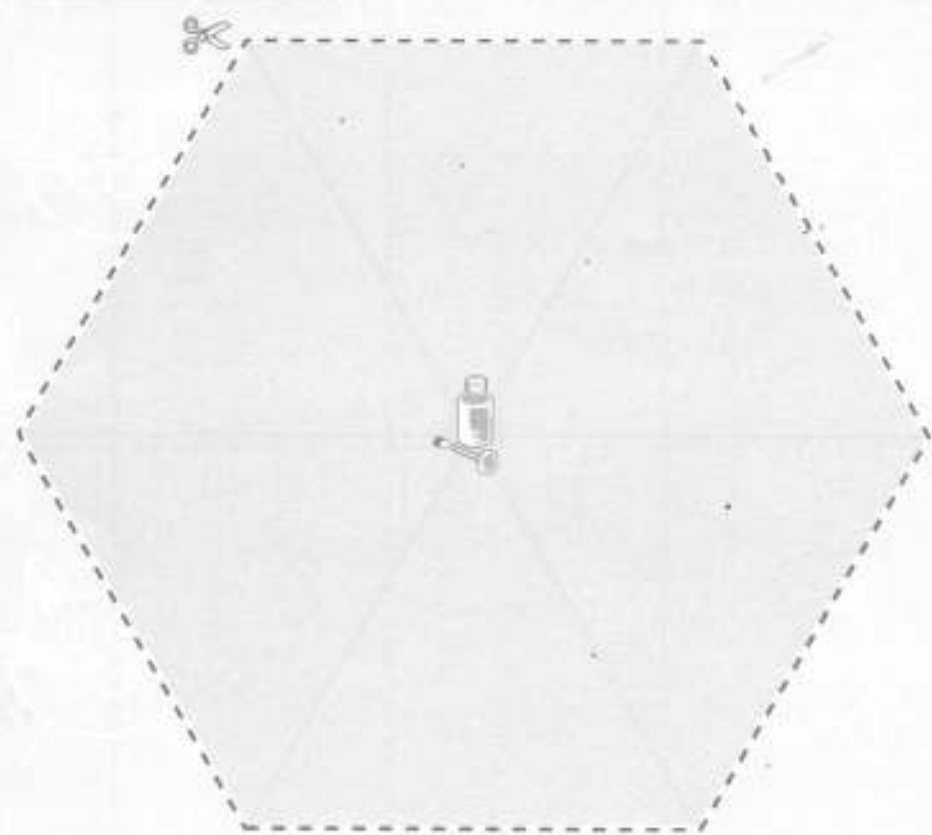

✂ Make mix-and-match people. --- = cut — = fold

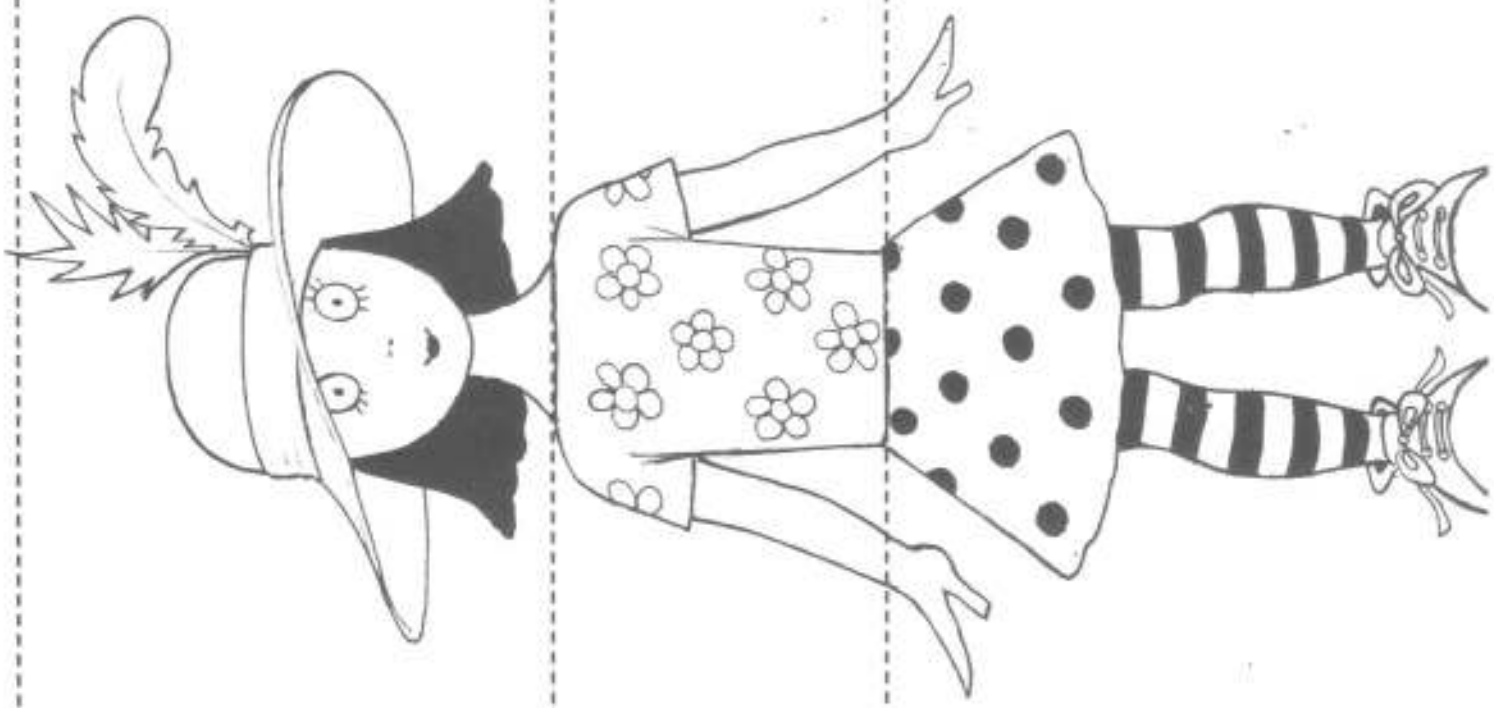

Unit 4 Lesson 7 cut-out



--- = cut — = fold



✂ Make a birthday game. --- = cut — = fold

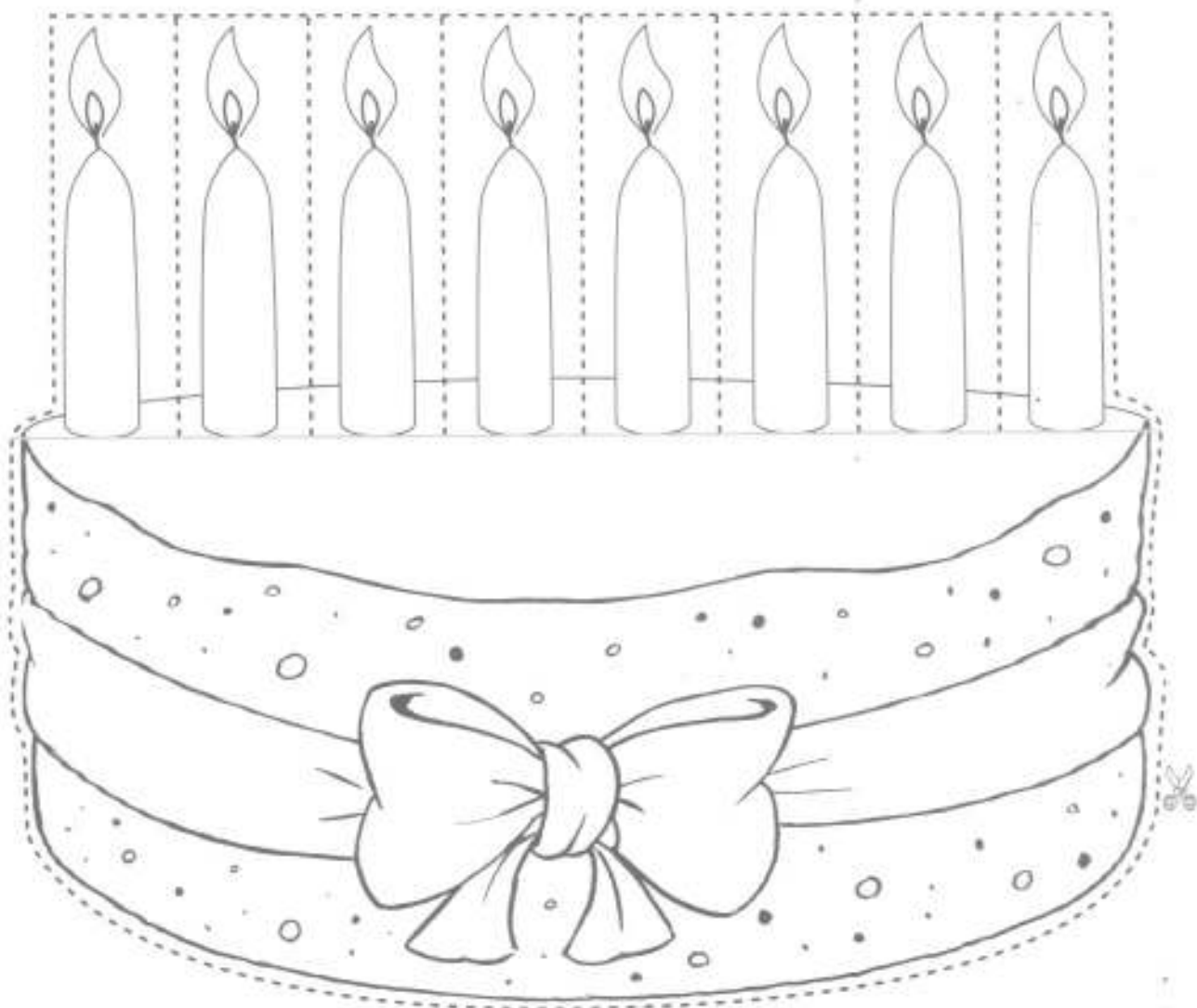



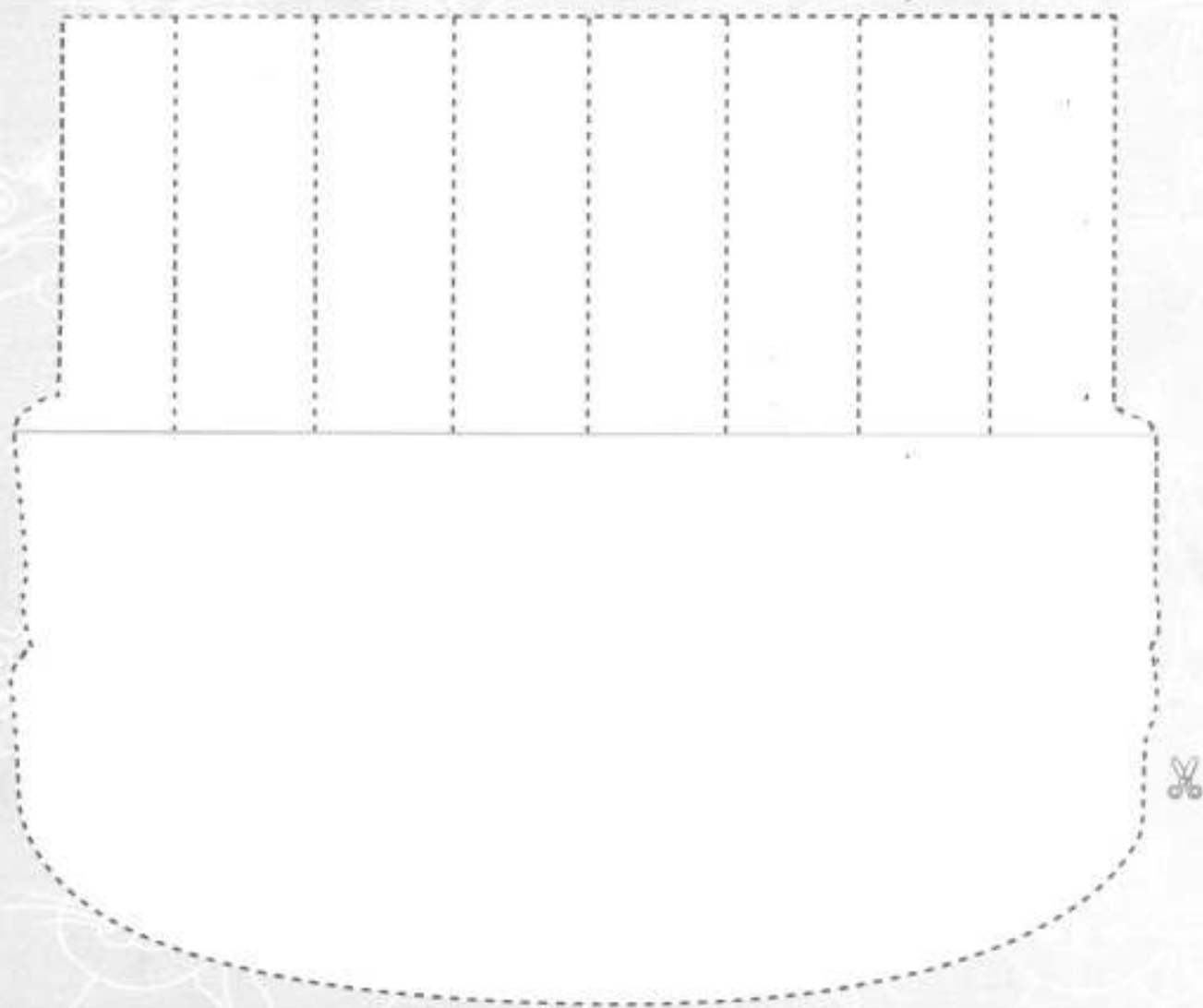
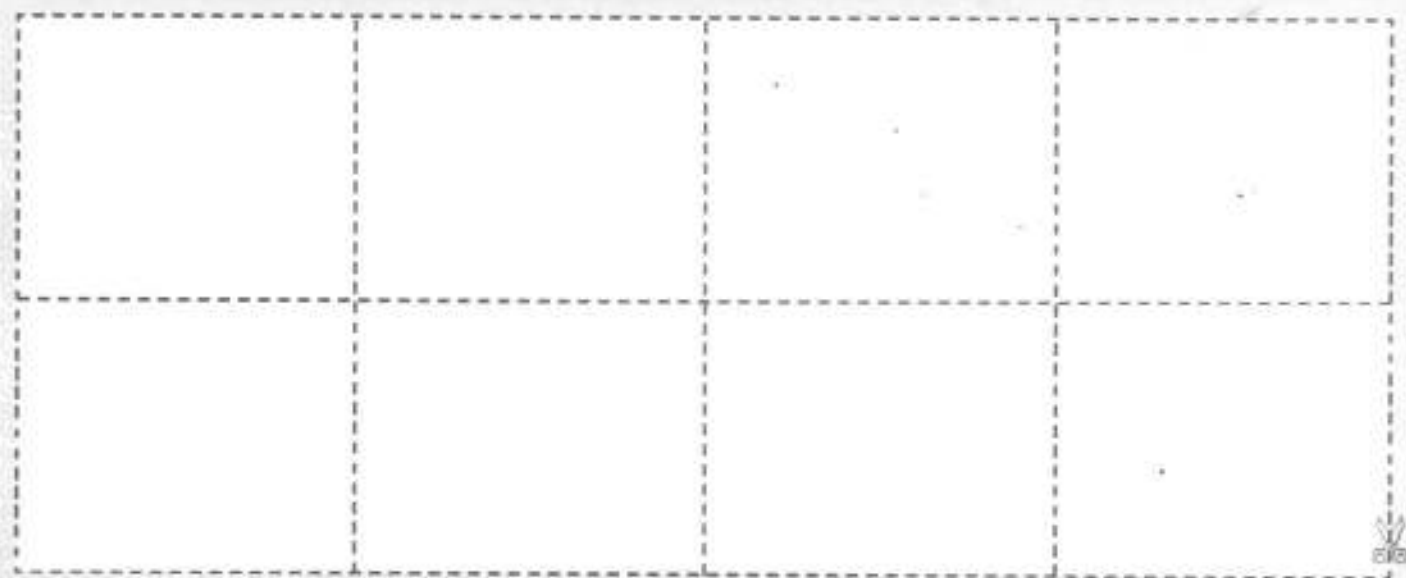

--- = cut — = fold



Ask your family and ✓ or X. --- = cut



Can you do this?			
1 			
2 			
3 			
4 			

--- = cut

Make and play a game. --- = cut

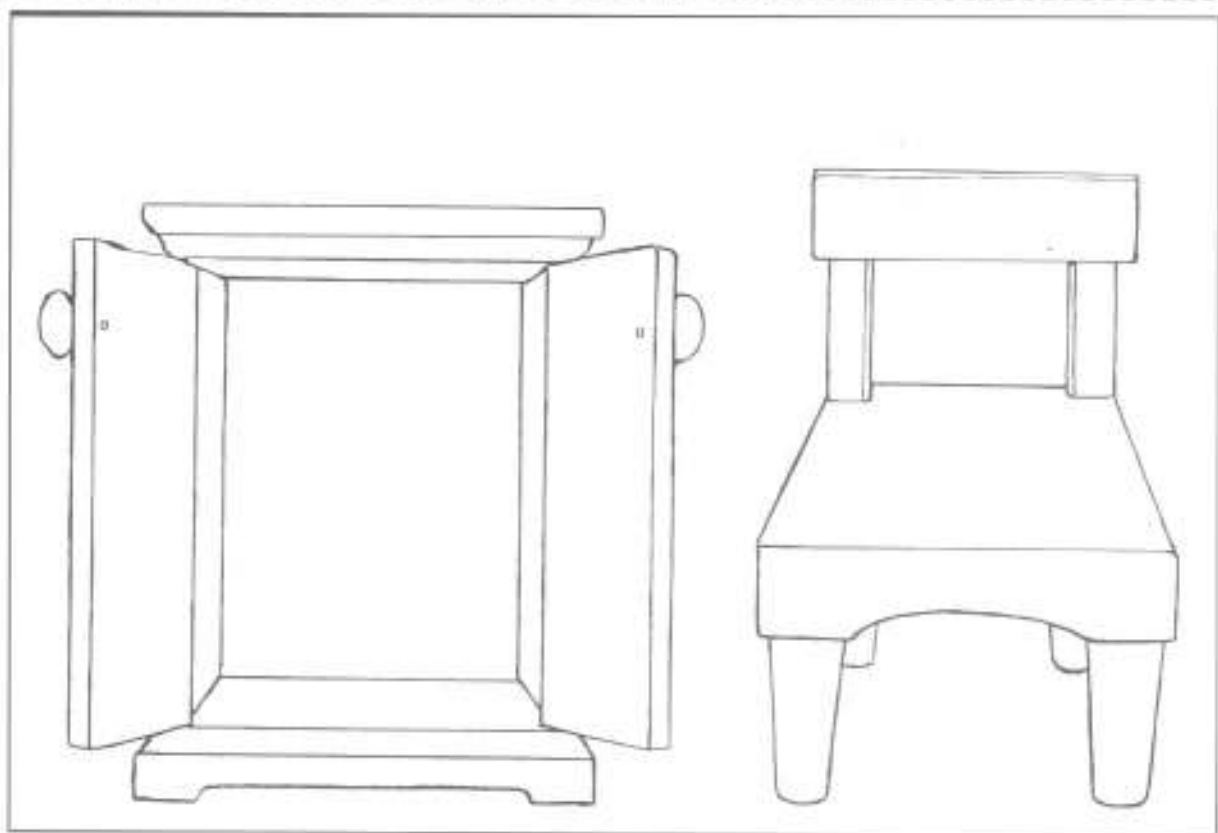
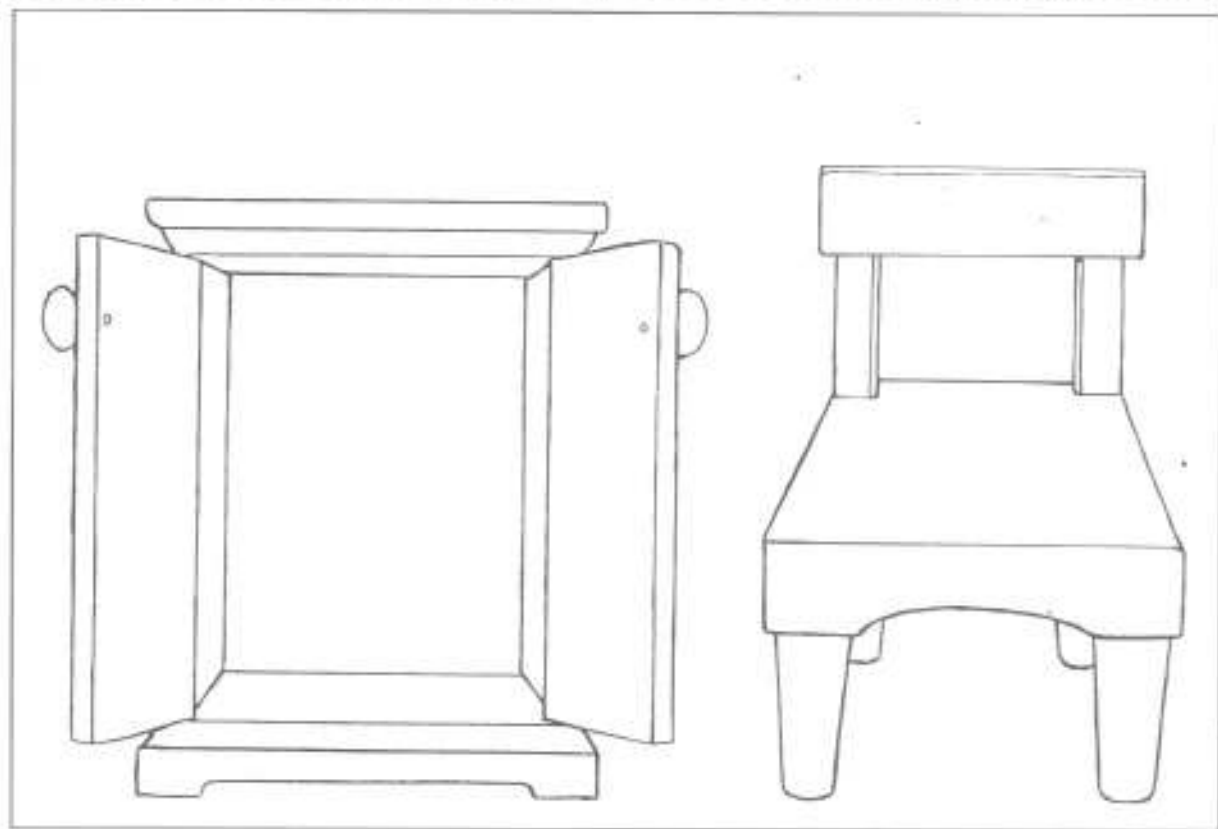

Unit 7 Lesson 7 cut-out

--- = cut

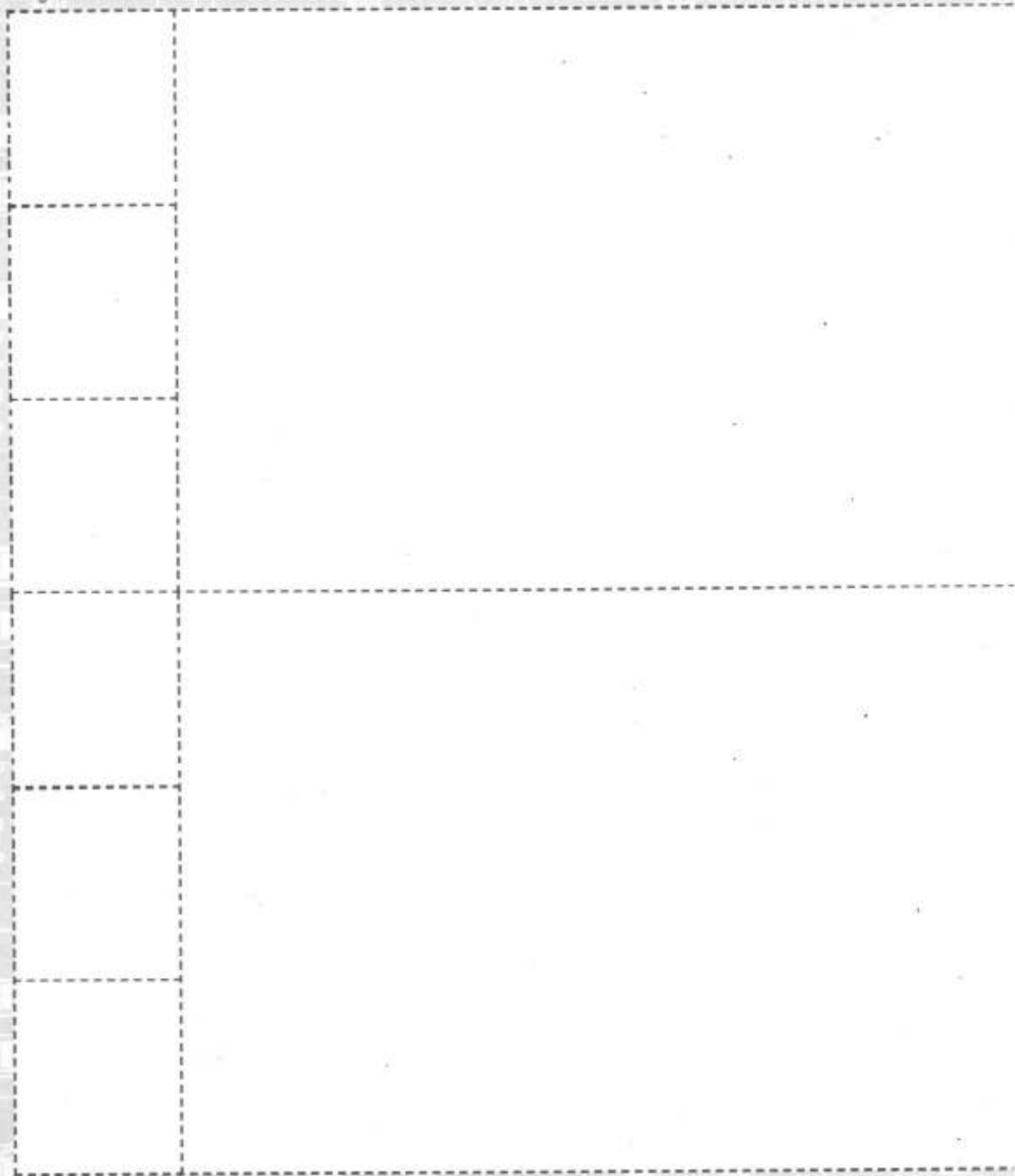

Happy House

New Edition

A new edition of the best-selling, story-based course for children starting English at the beginning of the school system. *Happy House* introduces children to English through the adventures of a lively family with their three children, their cat, Otto, and two mice, Spike and Ruby, who live under the floor.

The Activity Book contains:

- one page of practice activities per Class Book lesson
- motivating stickers for children to keep a record of their learning
- cut-out pages to make easy and rewarding craft activities
- take-home English: activities to involve parents in children's learning
- a MultiROM, with interactive language games, songs and stories

Website: www.oup.com/elt/happyhouse

OXFORD
UNIVERSITY PRESS

www.oup.com/elt

OXFORD ENGLISH
ISBN 978-0-19-473064-8



9 780194 730648